

# STL352C



Product Family	Dishwashers
Commercial width	60 cm
Commercial height	82 cm
Installation	Fully-integrated built-in
Kitchen panel	Not supplied
N° baskets	3, Flexi
EAN code	8017709306991



## Programs



N. of programmes	10+1	Mix	Yes
Washing temperatures	38, 45, 50, 55, 65, 70, 75 °C	Quiet (~2 dB)	Yes
Soak	Yes	Intense	Yes
Express 27'	Yes	Self clean	Yes
Crystal	Yes	Hygiene 99,9%	Yes
Full express - 60 minutes	Yes	Delicate	Yes
ECO	Yes		

## Options



Dry Assist+ option	Yes	1/2 load FlexiZone option	Yes
Delay timer option	Up to 24 hours	Special programs option	Yes

## Baskets



Basket colour	Grey	Largest loadable dish in upper basket	19,0 cm
Basket components colour	Grey	Lower Basket	With 2 foldable racks
Handle	In plastic on upper and lower basket	Lower basket with anti-drip inserts	Yes

<b>Upper Basket</b>	With central fixed racks	<b>Largest loadable dish in lower basket</b>	30,0 cm
<b>Glass holder</b>	Yes	<b>Colour Inner Components</b>	Blue
<b>Height adjustment of the upper basket</b>	On three levels (5 cm)		

## Technical Features



<b>Width (mm)</b>	598 mm	<b>Max water hardness</b>	100°fH;58°dH
<b>Depth (mm)</b>	545 mm	<b>Drying system</b>	Natural condenser drying, with Dry Assist + automatic door opening system at the end of the cycle
<b>Display type</b>	LED display (3 digit)	<b>Steam protection</b>	In plastic
<b>Product Height (mm)</b>	818 mm	<b>Tube material</b>	Stainless steel
<b>Controls</b>	Electronic	<b>Filter</b>	Stainless steel
<b>Display</b>	Delayed start, Programme time indicator	<b>Concealed heating element</b>	Yes
<b>Programme graphics</b>	Symbols	<b>Hinges</b>	Self balancing, Sliding, FLEXIFIT
<b>Salt light indicator</b>	Light	<b>Min. and max. frontal panel weight</b>	2,5 - 11 kg
<b>Rinse aid indicator</b>	Light	<b>Min. and max plinth height</b>	50 - 215 mm
<b>End of cycle indicator</b>	Acoustic signal	<b>Adjustable feet</b>	7 cm, from 820 to 890 mm
<b>Auto switch-off</b>	Yes	<b>Additional gaskets</b>	Yes, with stainless steel plate
<b>Washing system</b>	Orbital	<b>Back cover</b>	Yes
<b>Third spray arm</b>	Single	<b>Depth of dishwasher with open door (mm)</b>	1168 mm
<b>Water softener</b>	With electronic setting	<b>Back feet adjustable from front</b>	Yes
<b>Flood protection system</b>	Total Acquastop	<b>Top cover</b>	In plastic
<b>Water supply</b>	Single; cold/hot water max. 60°C - energysave with hot water up to 35%		

## Performance / Energy Label - Reg. 2019

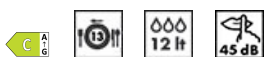

<b>Energy Efficiency Class</b>	C	<b>Programme duration</b>	4:10 h:min
<b>Energy consumption [per 100 cycles, based on the eco programme]</b>	73 kWh	<b>Airborne acoustical noise emissions</b>	45 dB(A) re 1 pW
<b>Rated capacity (ps)</b>	13	<b>Airborne acoustical noise emission class</b>	C
<b>Water consumption [per cycle]</b>	12,0 litres	<b>Energy efficiency Index (EEI)</b>	43,8

## Electrical Connection

<b>Connected power</b>	1800 W	<b>Type of connection</b>	Single-phase
<b>Current</b>	10 A	<b>Power supply cable length</b>	140 cm
<b>Voltage</b>	220-240 V		

Frequency (Hz)

50 Hz

Plug

(F;E) Schuko

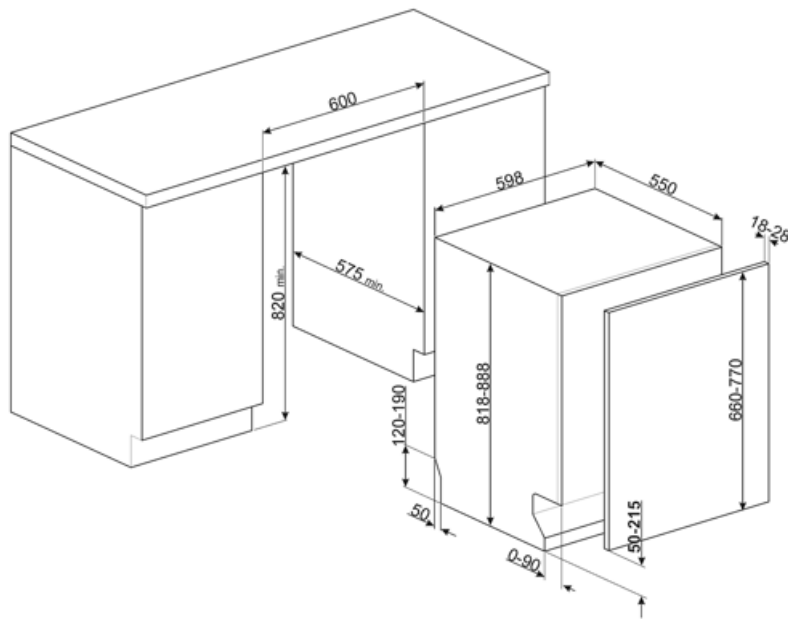

## Compatible Accessories



**KIT82CN**



**KIT82SPRAN**



**KIT82SPRX**



**KIT82CX**



**KIT82SPRMW**



**KITFLEXI**

Kit for 60cm dishwashers with FlexiFit hinges for door panel weight >11 kg (max 15 kg 82 cm and 13,5 kg 86 cm)



**KITGH**

Kit glass holder. It has to be fitted on the first basket but only if there are foldable racks



**KITPL60B**

Toe-kick Kit in White colour with adjustable height and deepness. Can be installed over all the fully integrated and underbench models with variable fulcrum or flexifit hinges.



**KITPL60N**

Toe-kick Kit in Black colour with adjustable height and deepness. Can be installed over all the fully integrated and underbench models with variable fulcrum or flexifit hinges.



**KITPL60X**























Toe-kick Kit in Stainless Steel with adjustable height and deepness. Can be fitted over all the fully integrated and underbench models with variable fulcrum or flexifit hinges.



**KITPLV2**

Kit extension for dishwasher and washing machine: lenght mt. 2

## Symbols glossary

 To improve the drying of dishes without leaving stains.	 Energy efficiency class C
 82 cm high	 Delay Timer: Option to postpone the start of the desired programme by up to 24 hours in order to programme the dishwasher to run at the desired time.
 The Dry Assist + option, in addition to saving energy, ensures perfect drying of the dishes by opening the door automatically at the end of the washing cycle.	 The FlexiFit hinges allow the kitchen panel to slide over the dishwasher door, allowing a minimum kitchen plinth height of 5 cm.
 FlexiZone: The 1/2 load flexizone allows you to wash a reduced load saving energy, water and time and there are no restrictions on where the items are placed.	 The work aimed at continuous improvement has allowed the creation of the second generation of the Inverter motor 2.0, characterised by greater efficiency and durability over time, which allows very high performance and a lower energy consumption and noise level.
 Noise Level: Excellent insulation and special devices keep noise to a minimum.	 Orbital wash system distributes water evenly throughout the 60cm dishwasher cavity, directing water with precision to ensure an excellent wash.
 Crystals: The Crystals programme is dedicated to delicate dishes such as glasses and china.	 Delicate: Delicate washing program is designed for delicate dishes which are not heavily soiled.
 Eco: Eco, this economic wash programme uses a low amount of water and energy in order to provide the most environmentally friendly cleaning option.	 Mix: The Mix programme is suitable for mixed crockery and everyday pots and pans, without any particular incrustation.
 Soak programme: The soak programme provides a rinse to prevent dirt from drying.	 Express 27': The Express 27' programme is a quick wash cycle, at low temperatures, for lightly soiled dishes.
 Ultraclean: The Ultraclean option performs a final rinse at a high temperature of 70°C eliminating virtually all bacteria.	 13 place settings: Number of place settings.
 Total Acquastop: In addition to the partial Acquastop protection present in all Smeg dishwashers, some models have an electronic device fitted to the water intake hose, which monitors water levels in the machine, detects leaks in the hose and switches off the water supply immediately when necessary.	 System WaterSave ensures the best washing results with minimal water consumption depending on the model of dishwasher.
 Quick wash cycle for normally soiled mixed loads such as dishes and pans, even with dried-on residues. Dishes are washed and dried in 60 minutes.	 Dishwasher cleaning cycle. The cycle should be started with the machine empty, without dishes. It is recommended to run the program every 2-3 months, using special dishwasher detergents.



**SILENT:** Wash cycle suitable for normally soiled dishes, even with dried-on residues. Ensures maximum noise reduction and is therefore ideal if you wish to run it during the night.



Allows you to enable additional programs when selected together with any wash cycle.



**HYGIENE 99.9%** High-temperature washing programme. The 75° rinse guarantees the removal of 99.9% of germs and bacteria.