



USER GUIDE

Thank you for purchasing this appliance.

Your range cooker has been designed and **built in the UK.**

This cooker is a **technical masterpiece**, the **embodiment of exquisite quality** and **stylish, thoughtful design.**

We hope you have many happy years creating memorable family meals and moments.

Please leave us a review on Trustpilot and share your experience.

 Trustpilot



Contents

| | | | |
|--|-----------|-------------------------------------|-----------|
| 1. Unboxing | 1 | 7. Cooking Tips | 34 |
| 2. Cooker Overview | 3 | Fan and Multifunction Oven | 34 |
| Your Appliance Layout | 3 | Bread Proving | 34 |
| Hob Layout Cooking Zone Layout | 4 | Slow Cook | 34 |
| Lights, Oven and Grill Identification | 5 | 8. Cleaning Table | 35 |
| Timer Display and Buttons | 6 | Cleaning Tips and Maintenance | 37 |
| Lights and Oven Identification - Single Cavity | 6 | 9. Help and Support | 40 |
| Set your Clock | 7 | 10. Installation - Dual Fuel | 44 |
| Set the Minute Minder | 7 | Location of Cooker | 44 |
| Set the Left-hand Oven | 8 | Positioning the Cooker | 46 |
| To stop the oven at a specific time of day | 8 | Fitting the Stability Chain | 47 |
| 3. Cooking Zone | 9 | Electrical Connection | 49 |
| Dual Fuel | 9 | 11. Installation - Induction | 50 |
| Induction | 11 | Safety Requirements and Regulations | 50 |
| Ceramic Hobs | 16 | Provision of Ventilation | 50 |
| 4. The Grill | 17 | Location of Cooker | 50 |
| Flexi-grill | 17 | Positioning the Cooker | 51 |
| Positioning the Grill | 17 | Electrical Connection | 53 |
| Fitting the Telescopic Runners | 17 | Final Checks | 53 |
| Grill Trivet Height Adjustment | 18 | Final Fitting | 53 |
| Fitting the Grill Pan | 18 | Customer Care | 53 |
| 5. The Ovens | 19 | 12. Legal Guide | 54 |
| Multifunction Oven | 19 | Before You Start ... | 54 |
| Fan Oven | 21 | Operation / Usage | 55 |
| Bread Proving Drawer | 22 | Electric Hobs | 63 |
| The Slow Cook Oven | 23 | Gas Hobs | 65 |
| Oven Shelves | 24 | 13. Warranty | 67 |
| Multifunctional Oven in Single Cavity | 26 | | |
| 6. Cooking Tables | 27 | | |
| Multifunction Oven - Conventional | 27 | | |
| Multifunctional Oven - Duo | 28 | | |
| Multifunctional Oven - Fan Assisted | 28 | | |
| Multifunctional Oven - Base Heat | 29 | | |
| Grill Cavity | 29 | | |
| Bread Proving Drawer | 30 | | |
| Slow Cook Cavity | 30 | | |
| Dual Fuel - Hotplate | 31 | | |
| Induction | 31 | | |
| Test House Test Dishes | 31 | | |
| Fan Oven | 32 | | |

Before you start...

Your cooker should give you many years of trouble-free cooking if installed and operated correctly. It is important that you read the Legal Guide and Installation section before you start.

1. Unboxing

Depending on your model, your appliance is supplied with certain accessories:

Supplied Accessories

- ▲ Supplied with induction appliances
- Supplied with appliance
- ◆ Supplied with dual fuel appliances
- Available as an optional extra























































































































































| | | 90/100 | 110 | 110 only | 90/100 | 110 | | |
|----------------------------|-----------------------|--------|-----|----------|--------|------|------|--|
| Cotswold | | ● | ● | ● | | | | |
| Camden | | ● | ● | ● | | | | |
| Estate | | ● | ◆ | ◆ | | | | |
| Classic | | ● | ◆ | ◆ | | | | |
| Infusion Classic | | ● | ◆ | ◆ | | | | |
| Professional+ | | ● | ◆ | ◆ | | | | |
| Infusion | | ● | ◆ | ◆ | | | | |
| Toledo | | ● | ◆ | ◆ | | | | |
| Longstock | | ● | ◆ | ◆ | | | | |
| Classic Deluxe | | ◆ | ◆ | ● | ◆ | ▲ | ▲ | |
| Estel Deluxe | | ◆ | ◆ | ● | ◆ | ▲ | ▲ | |
| Leckford Deluxe | | ◆ | ◆ | ● | ◆ | ▲ | ▲ | |
| Professional Deluxe | | ◆ | ◆ | ● | ◆ | ▲ | ▲ | |
| Longstock Deluxe | | ◆ | ◆ | ● | ◆ | ▲ | ▲ | |
| Encore Deluxe | | ◆ | ◆ | ● | ◆ | ▲ | ▲ | |
| Edge Deluxe | | ◆ | ◆ | ● | ◆ | ▲ | ▲ | |
| Arina Nexus | | ◆ | ◆ | ● | ◆ | ▲ | ▲ | |
| Elise | | ◆ | ◆ | ● | ◆ | ▲ | ▲ | |
| Stanley Supreme | | ◆ | ◆ | ● | ◆ | ▲ | ▲ | |
| * Single Cavity | Classic Deluxe | ◆ | ◆ | | ▲ | ■ x2 | ■ x1 | |
| | Estel Deluxe | ◆ | ◆ | | ▲ | ■ x2 | ■ x1 | |
| | Edge Deluxe | ◆ | ◆ | | ▲ | ■ x2 | ■ x1 | |
| | Arina Nexus | ◆ | ◆ | | ▲ | ■ x2 | ■ x1 | |
| | Elise | ◆ | ◆ | | ▲ | ■ x2 | ■ x1 | |

All sizes are in centimetres

| Grill Pan | Grill Trivet | Half Shelf | Energy Saving Panel | Telescopic Runners | Main Oven | Tall Oven Shelf | Plate Rack | Handyrack & tray |
|---|---|---|---|---|--|---|---|---|
|   Standard  Telescopic |  |  |  |  |  |  |  |  |



| | | | | 90/100 | 110 | 90/100 | 110 | | | |
|--|--|--|--|--|--|--|---|--|---|---|
|  | | | | | |  x2 |  x4 |  x4 |  | |
|  | | | | | |  x2 |  x4 |  x4 |  | |
|  | | | |  x1 |  x1 |  x2 |  x4 |  x4 |  | |
|  | | | |  x1 |  x1 |  x2 |  x4 |  x4 |  | |
|  | | | |  x1 |  x1 |  x2 |  x4 |  x4 |  | |
|  | | | |  x1 |  x1 |  x2 |  x4 |  x4 |  | |
|  | | | |  x1 |  x1 |  x2 |  x4 |  x4 |  | |
|  | | | |  x1 |  x1 |  x2 |  x4 |  x4 |  | |
|  | | | |  x1 |  x1 |  x2 |  x4 |  x4 |  | |
|  | | | |  x1 |  x2 |  x2 |  x4 |  x4 |  |  |
|  | | | |  x1 |  x2 |  x2 |  x4 |  x4 |  |  |
|  | | | |  x1 |  x2 |  x2 |  x4 |  x4 |  |  |
|  | | | |  x1 |  x2 |  x2 |  x4 |  x4 |  |  |
|  | | | |  x1 |  x2 |  x2 |  x4 |  x4 |  |  |
|  | | | |  x1 |  x2 |  x2 |  x4 |  x4 |  |  |
|  | | | |  x2 |  x4 |  x2 |  x4 |  x4 |  | |
|  | | | |  x2 |  x4 |  x2 |  x4 |  x4 |  | |
|  | | | |  x2 |  x4 |  x2 |  x4 |  x4 |  | |
| *  x2 |  x2 |  x3 |  x1 | | | | | | | |
| *  x2 |  x2 |  x3 |  x1 | | | | | | | |
| *  x2 |  x2 |  x3 |  x1 | | | | | | | |
| *  x2 |  x2 |  x3 |  x1 | | | | | | | |
| *  x2 |  x2 |  x3 |  x1 | | | | | | | |

2. Cooker Overview

This user guide covers a number of different series and models, and some features or functions are model specific. Therefore, some of the illustrations will look different from your particular model while the functions will be the same.

Your Appliance Layout

Fig. 2.1

110 cm Models

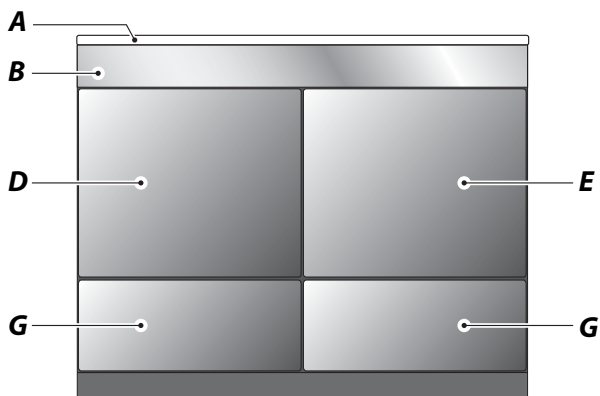
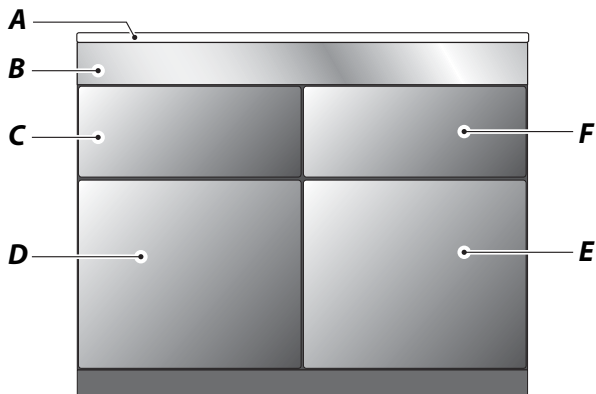
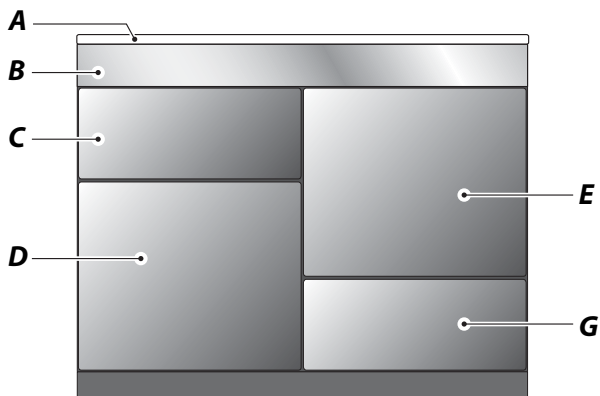

90 cm and 100 cm Models

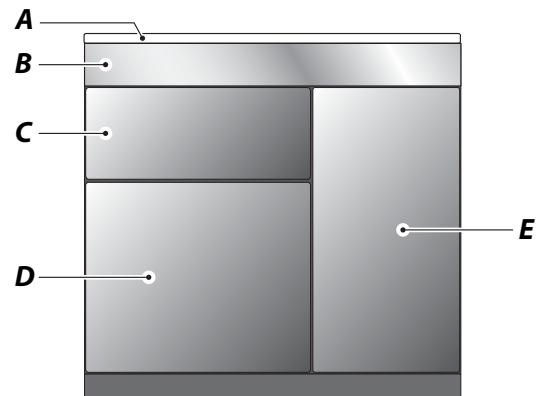

Single Cavity

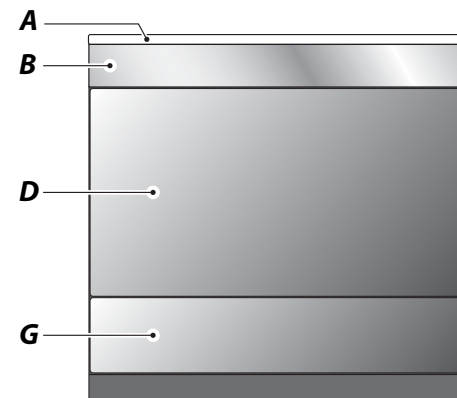

Your cooker (**Fig. 2.1**) may have the following features:

A. Cooking zone

- Dual Fuel - Hotplate burners, Wok burner or Ceramic multizone hotplate
- Induction hob **OR**
- Ceramic hob

B. Control panel

C. Flexi-grill / Grill

D. Multifunction oven / fanned oven

E. Fanned oven

F. Slow cook oven

G. Bread proving / Storage drawer

Hob Layout | Cooking Zone Layout

Depending on your appliance model series, its layout would be different.

Dual Fuel

90cm and 100cm

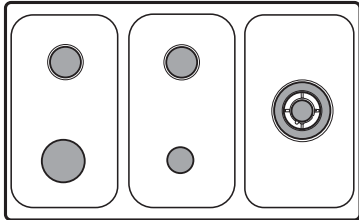

110cm

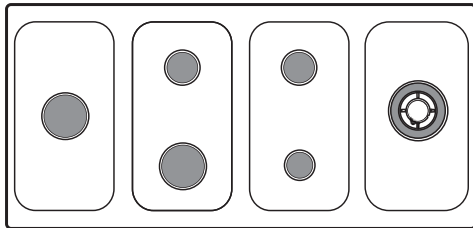

110cm with Multi-zone

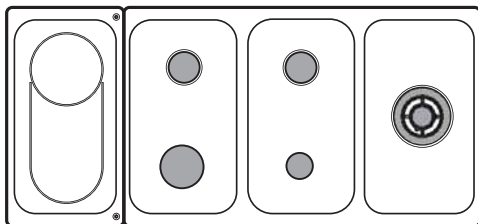

Ceramic

90cm and 100cm

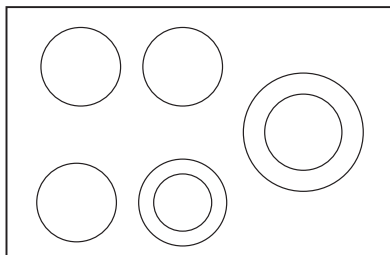

110cm

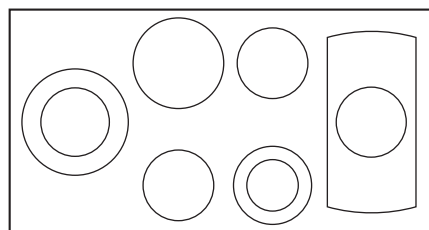

Induction

90cm, 100cm, and 110cm

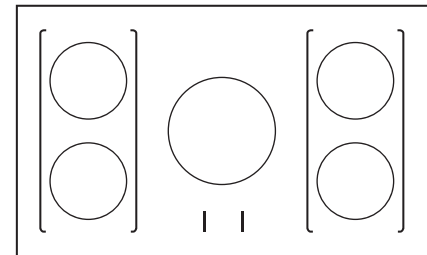
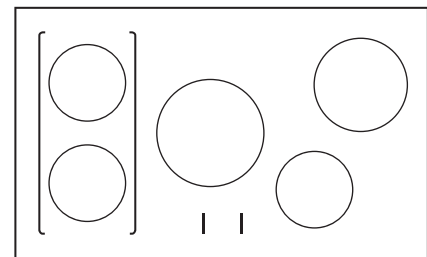
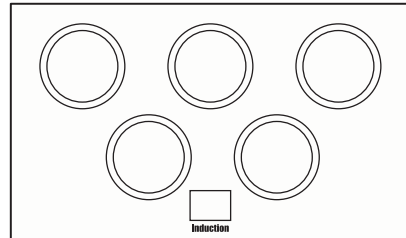

Lights, Oven and Grill Identification

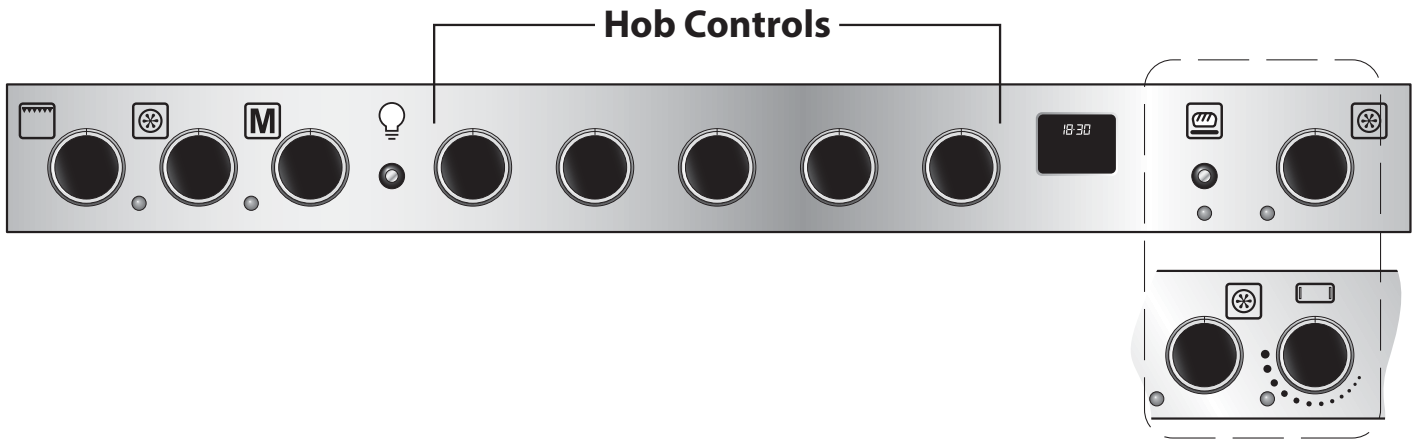

Besides the hob controls as highlighted above, there are other functional dials for your cooker.

| Symbol Neons | Description | Symbol Neons | Description |
|----------------|--|----------------|---|
| | Grill | | Bread Proving Drawer <ul style="list-style-type: none"> Operated by a push button; no need to set the temperature. |
| | Left-hand Oven Temperature Control <ul style="list-style-type: none"> The neon turns on when you turn or adjust the temperature of the oven. The neon turns off when the oven has reached the selected temperature. | | Slow Cook <ul style="list-style-type: none"> Turn the graduated temperature scale to either cook slowly for several hours (i.e. Conventional slow cooking), all day extended slow cooking or plate warming. |
| | Multifunction Oven Selector (if applicable) <ul style="list-style-type: none"> The neon turns on when you turn on and select the multifunction feature. | | Right-hand Oven Temperature Control <ul style="list-style-type: none"> The neon turns on when you turn or adjust the temperature of the oven. The neon turns off when the oven has reached the selected temperature. |
| | Oven Light <ul style="list-style-type: none"> Press the button to turn on the oven light. | | |

Lights and Oven Identification - Single Cavity

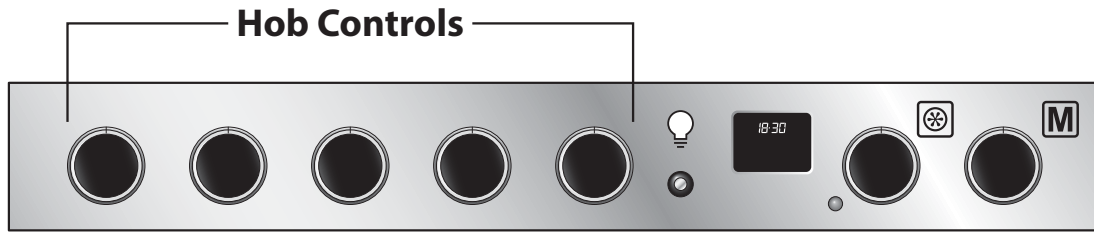

For **Single Cavity**, the hob dials are as highlighted above. Here are other functional dials for your cooker.

| Symbol Neons | Description | Symbol Neons | Description |
|----------------|--|----------------|---|
| | Oven Temperature Control <ul style="list-style-type: none"> The neon turns on when you turn or adjust the temperature of the oven. The neon turns off when the oven's reached the selected temperature. | | Multifunction Oven Selector <ul style="list-style-type: none"> The neon turns on when you turn on and select the multifunction feature. |
| | | | Oven Light <ul style="list-style-type: none"> Press the button to turn on the oven light. |

Timer Display and Buttons

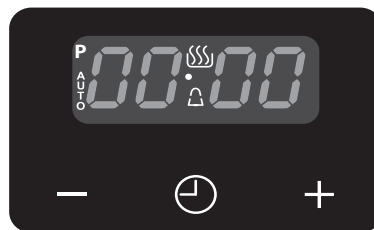

| Display Buttons | Description | Display Buttons | Description |
|-------------------|--|-------------------|--|
| AUTO | AUTO cooking mode | | <ul style="list-style-type: none"> Press the buttons (+ / - / ⌚) to set and adjust time, to set and reset the minute minder, to start and stop the cooking, and to change the alarm tone. |
| | Cook symbol | | |
| | Alarm symbol <ul style="list-style-type: none"> Displayed when you set the minute minder | | |
| | Decimal point <ul style="list-style-type: none"> In clock setting mode, the decimal point [•] will flash. | | |
| dur End | <ul style="list-style-type: none"> It is the duration time you want the oven to cook while setting the stop cooking time for your oven. | | |
| ton1 | Alarm tone <ul style="list-style-type: none"> There are 3 alarm tones for you to select. | | |

Fig. 2.2

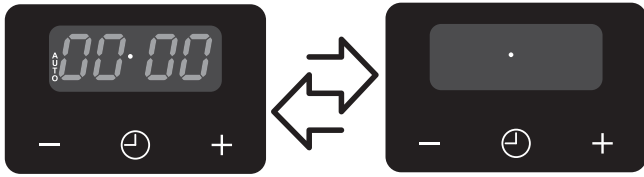

After you power on your appliance, a flashing oven clock 00:00 and **AUTO** indicate that the clock was not set (Fig. 2.2).

*** IMPORTANT**

The clock must be set to the time of day before the oven will work.

Set your Clock

There are 2 ways to set. (Fig. 2.3)

1. Press or Press + and - together.
 - ↳ Both 00:00 and flash.
2. Use + and - to adjust the time.
 - ↳ Once the time is adjusted, the clock will confirm automatically after a few seconds; or
 - ↳ You can press to confirm.

Fig. 2.3

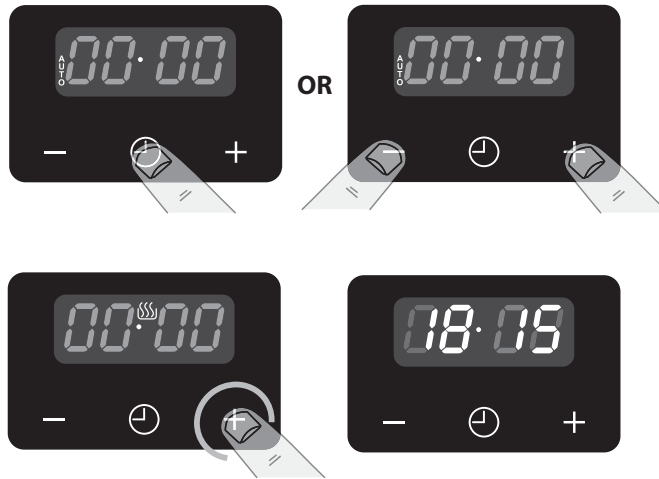

Reset your clock

If you want to change the time after the clock has been set, you can:

1. Press + and - together.
 - ↳ 00:00 flashes.
2. Use + and - to adjust the time.
 - ↳ Once the time is adjusted, the clock will confirm automatically after a few seconds; or
 - ↳ You can press to confirm.

Fig. 2.4



Set the Minute Minder

1. Press in clock mode. (Fig. 2.4)
 - ↳ 0:00, , and display.
2. Use + and - to adjust the minute minder.

In case you need to reset, press again and then press + and - simultaneously

Once the countdown timer has elapsed, the alarm will sound.

To stop the alarm, press any button.

Set the Left-hand Oven

You have set the required temperature and function mode, and you would like the oven to work automatically.

Change from Auto to Manual cooking

During the oven cooking, you might want to change from auto to manual.

Simply press either **+** or **-** to revert to manual cooking.





Change the alarm tone

You can change the alarm tone of your oven. (Fig. 2.5)

1. Press **+** and **-** together in clock mode.
 - ↳ The **.** flashes.
2. Press  to display *ton!*.
3. Press **-** to toggle between different tone.
 - There are 3 tones in total.

To stop the oven at a specific time of day

(Main oven only) You have set the required temperature and function mode and you would like the oven to automatically stop. (Fig. 2.6 page 8)

1. Long press  3 times while **AUTO** flashes.
 - ↳ *dur* and *00 00* appear alternately.
 - ↳ **AUTO** remains flashing and  is visible.
 2. Use **+** and **-** to set the length of time you want the oven to cook for, for example 30 minutes duration.
 - ↳ Leave it be and the countdown starts automatically. **AUTO** and  remain visible.
 - ↳ When cooking has finished, alarm sounds, **AUTO** flashes and  disappears.
 3. Press any button to stop the alarm.
- * **IMPORTANT**
REMEMBER Turn the oven control knob(s) to 0.

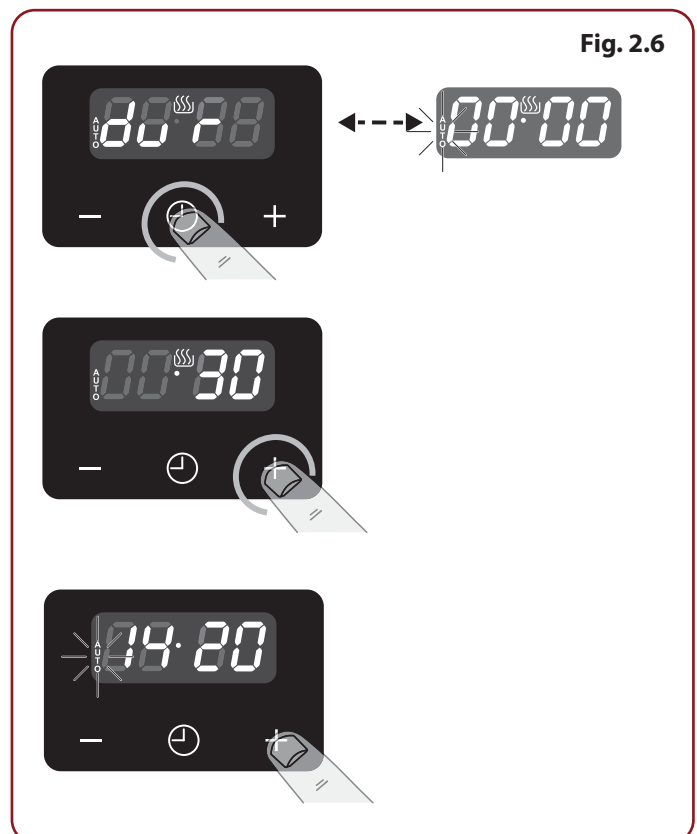
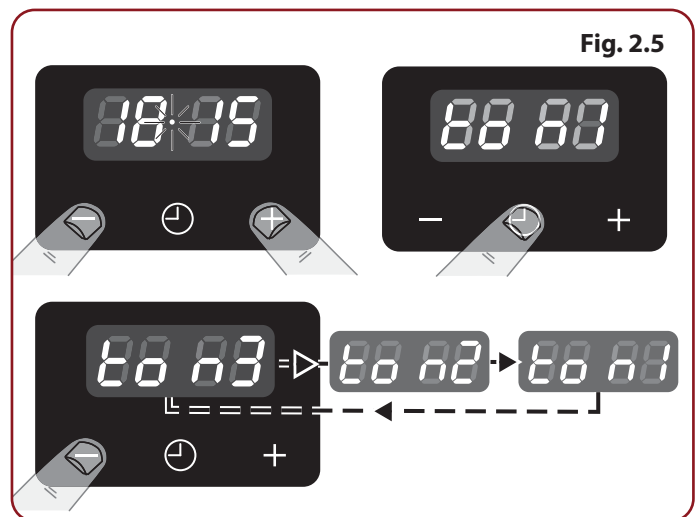

3. Cooking Zone

Fig. 3.1

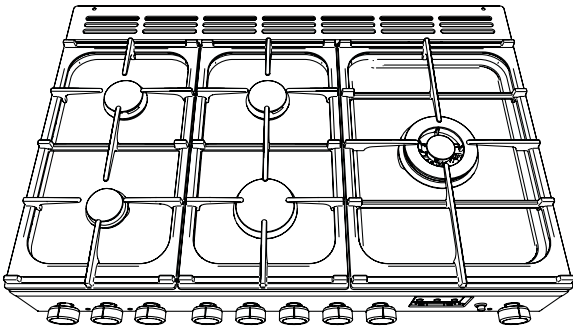

Dual Fuel

Hotplate Burners

90cm and 100 cm (Fig. 3.1)

110 cm (Fig. 3.2)

110 cm with Multi-zone (Fig. 3.3)

Each burner has a Flame Supervision Device (FSD) that prevents the flow of gas if the flame goes out.

- When a hotplate control dial is pressed in, sparks will be made at every burner – this is normal. Do not attempt to disassemble or clean around any burner while another burner is on, otherwise an electric shock could result.

Fig. 3.2

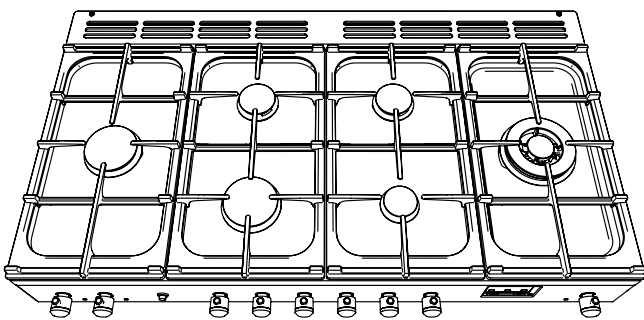

To light a burner, push in and turn counter-clockwise the associated control dial.

The igniter should spark and light the gas. Keep holding the dial pressed in to let the gas through to the burner for about ten seconds. Turn to adjust the flame height.

If, when you let go of the control dial, the burner goes out, then the FSD has not been bypassed. Turn the control dial to the OFF (0) position and wait for one minute before you try again, this time making sure to hold in the control dial for slightly longer.

- Make sure that the flames are under the pans. Using a lid will help the contents boil more quickly.
- Large pans should be spaced well apart.
- You should also avoid using unstable and misshapen pans that may tilt easily, and pans with a very small base diameter, e.g. milk pans, single egg poachers.
- DO NOT use cooking vessels on the hotplate that overlap the edges.

Fig. 3.3

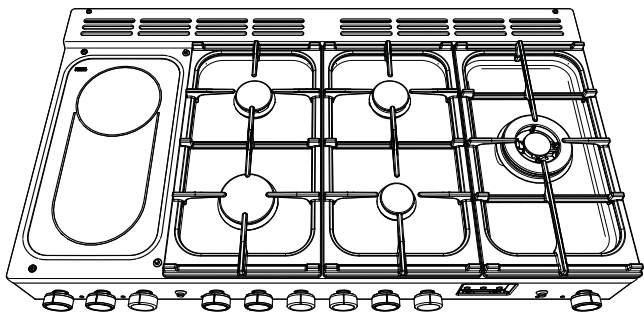

Wok Burner

The wok burner is designed to provide even heat over a large area. It is ideal for large pans and stir-frying. For heating smaller pans, the aforementioned hotplate burners may be more efficient.

Wok Cradle

Make sure your wok fits the cradle. Woks vary very widely in size and shape. It is important that the wok sits down on the pan support. (Fig. 3.4) The cradle should be used on the wok burners only. Securely place it on a pan support and that the wok is sitting level in the cradle.

- The cradle will get very hot in use – allow plenty of time for it to cool before you pick it up.

Fig. 3.4

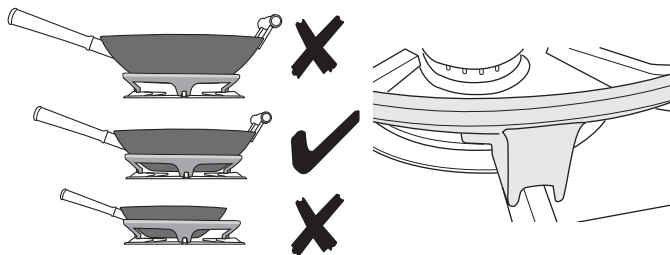

Ceramic Hotplate

The hotplate area on the left-hand side is dual purpose. It can be used either as a ceramic hob to heat a pan in the usual way or it can be used to heat the supplied deluxe griddle. (Fig. 3.5)

The rear area, marked with a ring, is for cooking with a pan.

There are two elements that allow either the whole of the area to be heated or just the rear half.

- To heat the whole area like a hob, turn the hotplate control *clockwise*.
- To use the rear ring only as a warmer, turn the hotplate control *counter-clockwise*.
- The neon indicator light above the control dial will come on when the hotplate control is turned on and stay lit while the surface cools.
- Always take care before touching the surface even when it is turned off – it may be hotter than you think.
- When cooking on the hob you may see the hob area you are using switch off and on. This is caused by a safety device that limits the temperature of the hob. It is quite normal, especially when cooking at high temperatures. If it happens a lot with a particular pan however it may mean the pan is not suitable – perhaps too small or too uneven – for a ceramic hob.
- For best results, preheat a covered serving dish for 10 minutes before adding food to it.
- Use only heat-resistant dishes.

Griddles

Deluxe Griddle

The deluxe griddle is designed to fit securely on the locating pins over the ceramic heating area. There is a gap at the right-hand rear corner of the griddle, so you can pour off excess fat after cooking (Fig. 3.6).

Classic Griddle

The classic griddle fits the left-hand pan support, front to back (Fig. 3.7).

⚠ Do not put it crossways nor on any other burner – it will not fit properly and will be unstable (Fig. 3.8).

⚠ Never fit two griddles side by side. Always leave space around the griddle for the gas to escape.

Both griddles are designed for cooking food on directly. **DO NOT** use pans of any kind on it. The surface is non-stick and metal cooking utensils (e.g. spatulas) will damage the surface. Use heat resistant plastic or wooden utensils.

Preheat the griddle for a **maximum of 5 minutes** before adding food. Leaving it longer may cause damage.

⚠ Be careful – it may be very hot.

After cooking, allow the griddle to cool before cleaning.

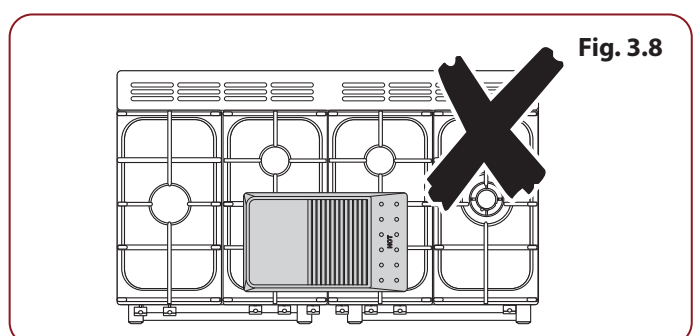
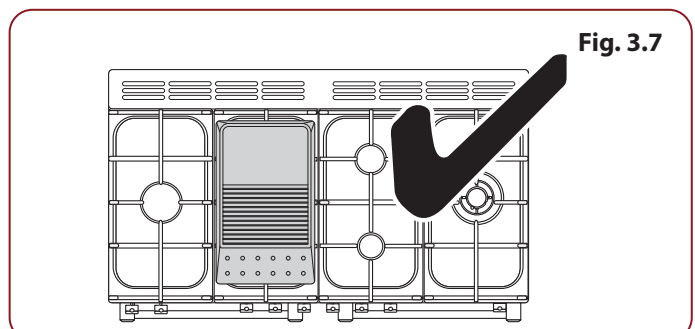
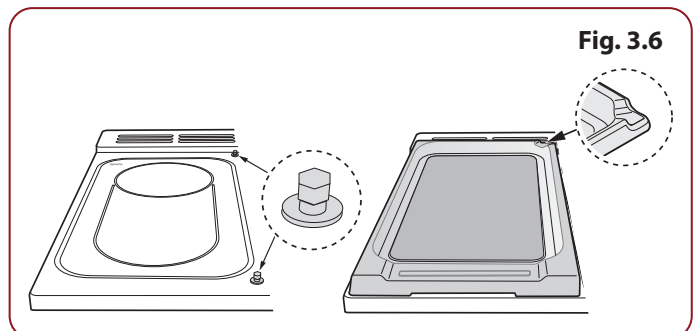
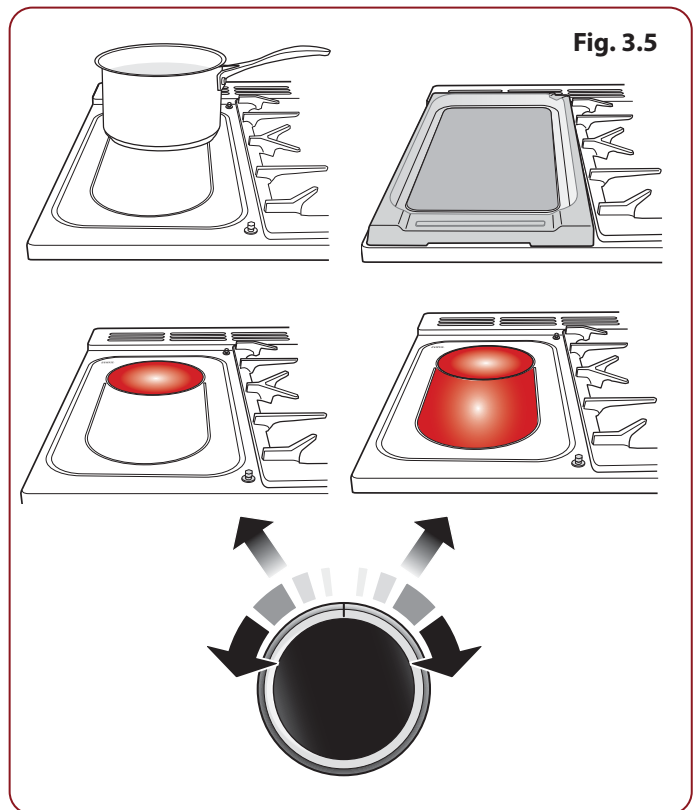
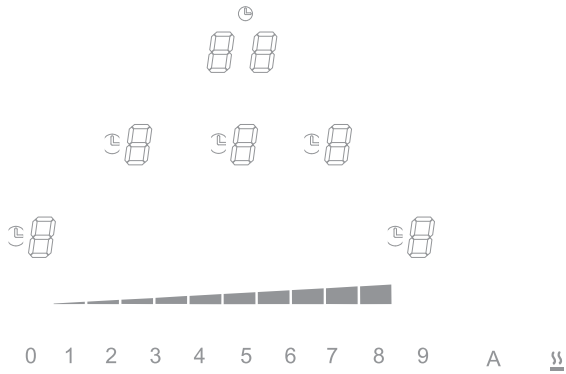
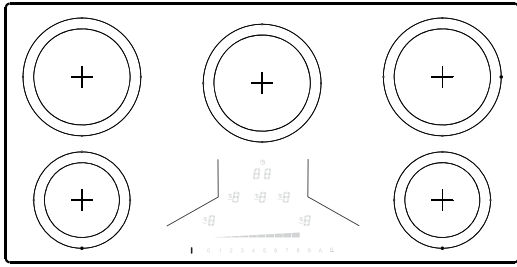

Fig. 3.9



Induction

For Kitchener

Pan Performance Check

Use a 1.85 kW zone (refer to manual for ratings of each zone).

Fill an unlidged pan with 1/2 litre of room temperature water (the diameter of pan should not be greater than the outer circle of the zone).

Operate the zone at power level 9.

The water should boil within 3½ minutes.

Boiling times outside this duration would suggest that the pan construction is not ideal to provide best performance and can result in premature component failure.



| Operation Sequence [Press Press & Swipe] | Display | Function |
|--|-------------------|--|
| | CL | • Power on and Timer ready |
| 0 → ss | - ss flash 0 1 | • Low Temperature Settings - Level 1 only |
| 0 → A | A | • Automatic Heat-up (if available) |
| CL → 0 → 0 1 2 3 | 99 | • Timer Setting, with maximum 99 minutes. • 1 minute timer; count down from 59 seconds. |

| Display | Function |
|------------------------------|--|
| 0...9 0 1 2 3 4 5 6 7 8 9 | • Temperature settings - Level 1 to 9 |
| P | • Power Boost Setting |
| H | • Residual Heat Indicator |
| U | • No Pot indication |
| 0 | • Pot/ Pan detected on the respective zone |
| E # | • Request for Service Support |
| ER | |
| EH | |
| Er | |

Kitchener control display (Fig. 3.9)

For Professional+ / Professional Deluxe

Pot Performance Check

1. Place it on relevant cooking zones to grade.
2. Press  and then press  3 times.
3. Press .

The zone starts grading the pot, and the flashing sequence of  will display.







When the check is complete, the display shows:-

Grade 3 [] means Excellent; optimum cooking performance.

Grade 2 [] means Average; reduced cooking performance.

Grade 1 [] means Poor.

Professional +/ Professional Deluxe Control Display (**Fig. 3.10**):-

| Operation Sequence [Press] | Display | Function |
|---|---------------|--|
|  | L | • Child Lock |
|  | n | • Activate/ deactivate bridge function |
|  | | • Pause all cooking zones |
|  →   | TIMER 99 | • Timer Setting, with maximum 99 minutes. |
| LOW →  | LOW 1...2...3 | • Low Temperature Settings - Level 1 to 3 only |

| Display | Function |
|---------|---------------------------------------|
| 1...9 | • Temperature settings - Level 1 to 9 |
| P | • Power Boost Setting |
| H | • Residual Heat Indicator |
| t, | • Request for Service Support |
| u | • No Pot indication |

Fig. 3.10

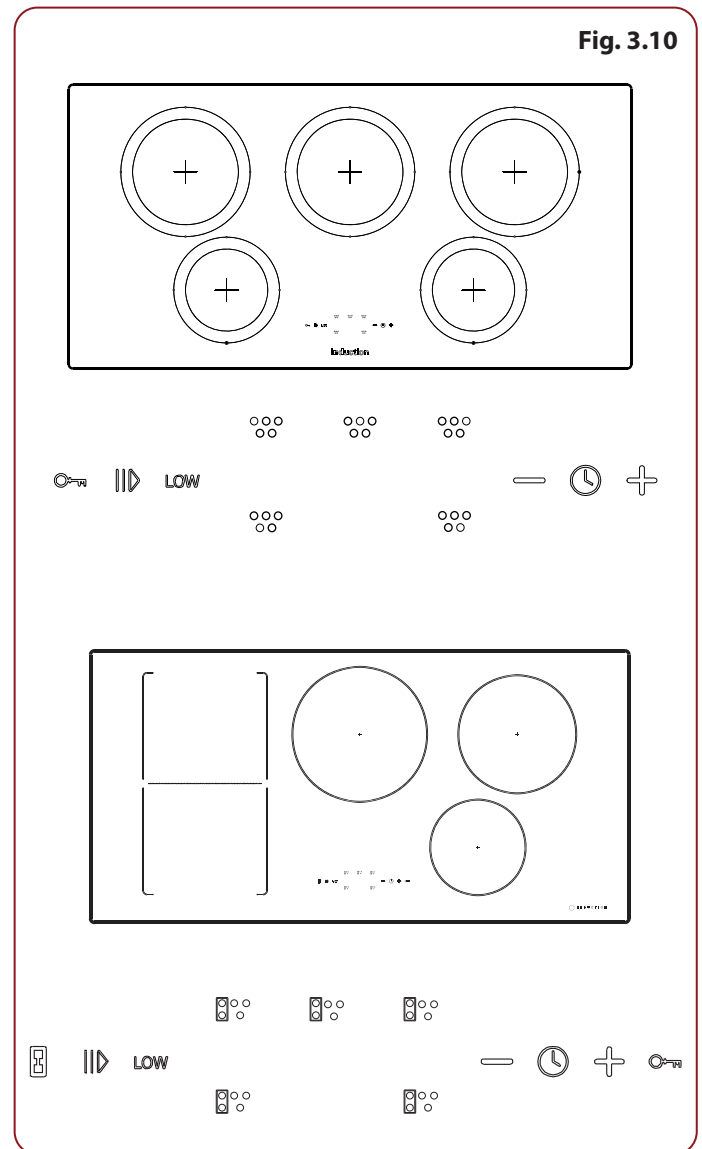

Fig. 3.11

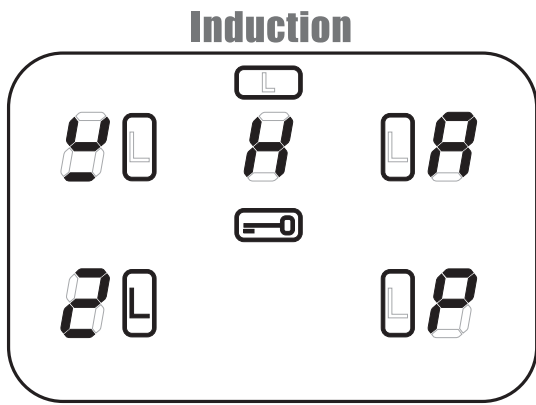
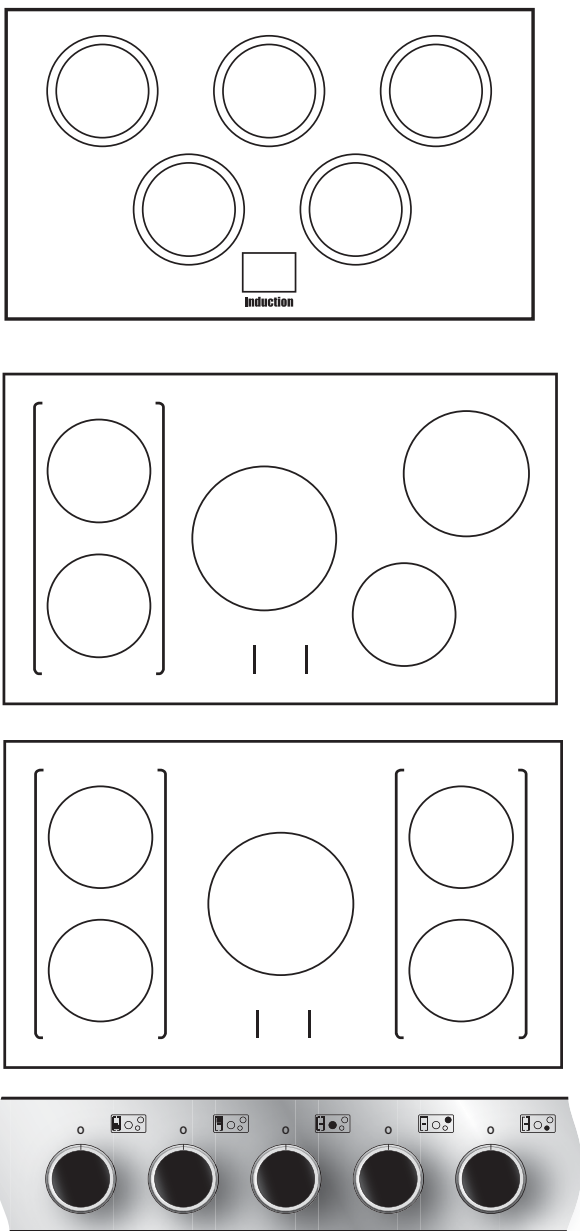

Fig. 3.12



For Standard Hob

Pan Performance Check

Use a 1.85 kW zone (refer to manual for ratings of each zone).

Fill an uncladded pan with 1/2 litre of room temperature water (the diameter of pan should not be greater than the outer circle of the zone).

Operate the zone at power level 9.

The water should boil within 3½ minutes.

Boiling times outside this duration would suggest that the pan construction is not ideal to provide best performance and can result in premature component failure.

The induction hob comprises of five cooking zones containing induction elements with different ratings and diameters, each with a pan detector and residual heat indicator, and a hob control display.



Standard hob control display (Fig. 3.11):-

| | |
|--|---|
| | Pan Detector |
| | Residual Heat Indicator |
| | Automatic Heat-up (if available) |
| | Child Lock |
| | Low Temperature Settings 1 - Melt: 2 - Simmer: |
| | Low Temperature Settings 1 - Melt: 2 - Keep Warm: 3 - Simmer: |
| | Power Boost Setting |
| | 2 Pot or Glass temperature is too high. Let the system to cool down. |
| | 3 Unsuitable cookware; perform the pan performance check or try another cookware. |
| | Er-E Manual power reset. If issue persists, contact customer service. |



Standard hob induction arrangement and bridging zone arrangement (Fig. 3.12).

Pan Detector

IMPORTANT: After use, switch off the hob element by its control and **DO NOT RELY** on the pan detector.

If a cooking area is switched on and there is no pan in place or if the pan is too small for the cooking area, then no heat will be generated. The symbol  will appear on the hob control display; this is the “pan-missing symbol”. Place a pan of the correct size on the cooking area and the  will disappear and cooking can begin. After 10 minutes without detecting a pan the cooking zone will switch off automatically.

Residual Heat Indicator

After use, a cooking zone will remain hot for a while as heat dissipates. When a cooking zone is switched off the residual heat indicator symbol , will appear in the display. This shows that the cooking zone temperature is above 60 °C and may still cause burns. Once the temperature has dropped to below 60 °C the  will go out.

Automatic Heat-up

This function is available on all of the cooking zones. It allows rapid heating up of the element to bring the selected cooking zone up to temperature. Once the zone is at the required cooking temperature the power level will reduce automatically to the preset level.

The function is selected by turning the control dial to the ‘A’ position. Turn the control dial momentarily counter-clockwise from the zero position until the symbol  is shown on the hob control display.

Once the  is displayed, turn the control dial to the level of your choice (1 to 9). The pan will heat up at 100% power for a specified time before the power is reduced to the level selected.

When the Automatic Heat-up function is activated, the hob control display will flash alternately between the  setting and the chosen power level.

Once the Automatic Heat-up time has ended the hob display will stop flashing and will show the chosen power level.

The Automatic Heat-up function can be stopped by either turning the control dial back to the “0” power setting or turning the control dial to the “9” power setting.

Child Lock

IMPORTANT: The child lock can only be activated when all the cooking zones are switched off.

To prevent the unwanted use by children, the hob can be locked.

To lock the hob, simultaneously turn the two left-hand controls counter-clockwise (**Fig. 3.13**) and hold until the  symbol appears in the centre of the hob control display.

- **NOTE:**  will flash when locking the hob – this is normal.
- Locking the hob will **NOT** affect the ovens; they can still be used.

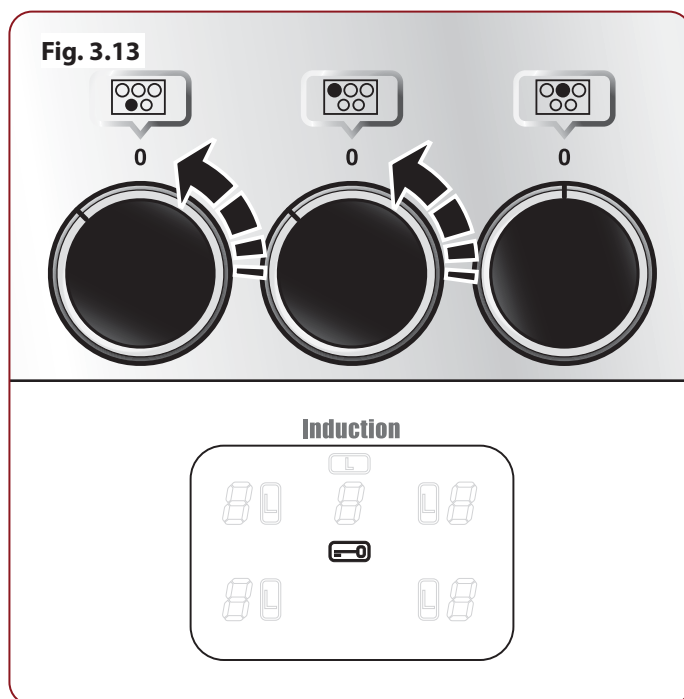

| Power Level | Maximum Operating Time |
|----------------------------|------------------------|
| L1, L2 and L3 if available | 2 hours |
| 1 | 6 hours |
| 2 | 6 hours |
| 3 | 5 hours |
| 4 | 5 hours |
| 5 | 4 hours |
| 6 | 1.5 hours |
| 7 | 1.5 hours |
| 8 | 1.5 hours |
| 9 | 1.5 hours |
| Power Boost | 10 minutes |

Table 3.1

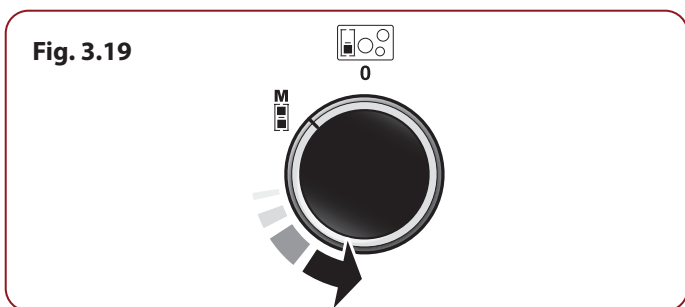
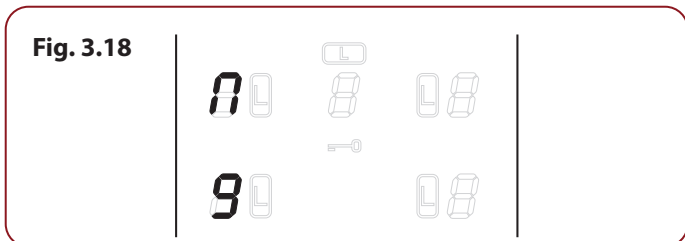
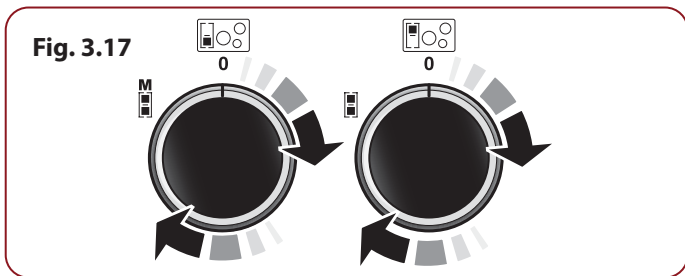
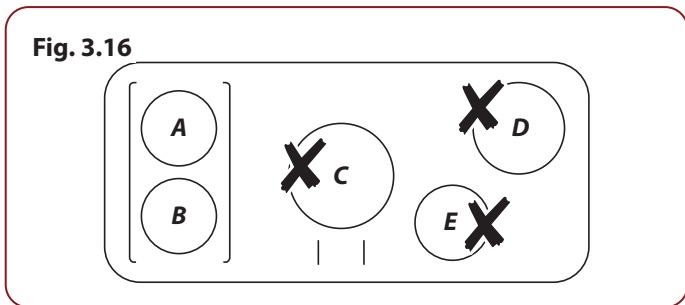
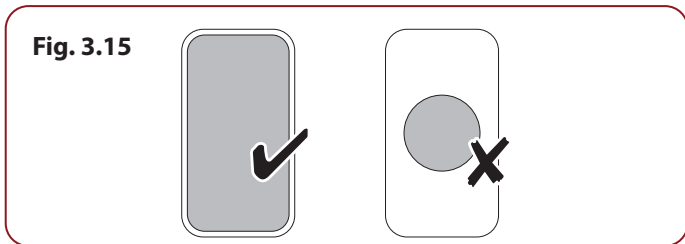
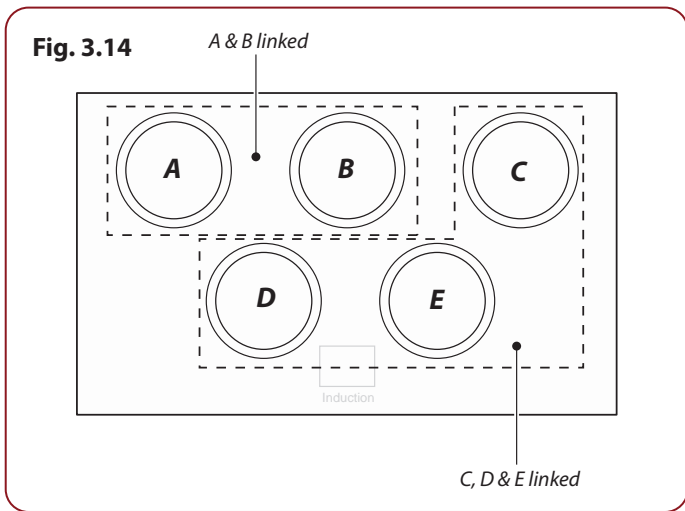

To unlock the hob, simultaneously turn the two left-hand controls counter-clockwise and hold until the symbol disappears from the centre of the hob control display.

Low Temperature Setting L1/L2

- L1 will maintain a temperature of about 40°C – ideal for gently melting butter or chocolate.
- L2 will maintain a temperature of about 90°C – ideal for simmering (bring the pan to the boil and then select L2 to keep soups, sauces, stews, etc at an optimal simmer).

Low Temperature Setting L1/L2/L3

- L1 will maintain a temperature of about 40°C – ideal for gently melting butter or chocolate.
- L2 will maintain a temperature of about 70°C – ideal for keeping food warm, once it has been cooked.
- L3 will maintain a temperature of about 90°C – ideal for simmering (bring the pan to the boil and then select L3 to keep soups, sauces, stews, etc at an optimal simmer).

(Table 3.1) The maximum time these settings can be used is 2 hours, after which the hob will switch off automatically. If required, you can immediately restart the Low Temperature function by reactivating L1 or L2. To increase the heat, just turn the control dial to the required level.

Power Boost Setting P

All of the induction cooking zones have Power Boost available, activated by turning the control dial clockwise until [P] is shown on the hob control display.

Power Boost allows additional power to be made available for each of the cooking zones. This is useful to bring a large pan of water to the boil quickly.

The Power Boost function operates for a maximum of 10 minutes on each zone, after which the power is automatically reduced to setting 9.

When using the Power Boost function, the cooking zones are linked (**Fig. 3.14**).

- This is a built-in safety feature.

This means that when using zone A on Power Boost and then switching zone B to Power Boost, the power to zone A will reduce slightly. The last zone switched to Power Boost always takes priority. Zones C, D and E work in the same way.

Turn the control dial to lower the setting and to deactivate this function.

The Bridging-Zone Function,

Zones A and B can be bridged, creating an area, ideal for use with an induction griddle (optional extra).

- **Note:** The griddle should comprise of an induction friendly, flat bottom, large enough to cover zones A and B of the hotplate heating area **Fig. 3.15**.

DO NOT use zones C, D or E to heat the griddle (**Fig. 3.16**).

To activate the bridging-zone function, simultaneously turn the two left-hand controls completely clockwise (Fig. 3.17) and hold until the [7] symbols appear in the centre of the hob control display (Fig. 3.18). The temperature can then be adjusted using the left-hand dial (Fig. 3.19).

Turn both dials counter-clockwise to cancel the function and return to normal operation.

⚠ DO NOT turn the two left-hand dials individually to heat the griddle. This can cause excessive temperatures and damage the coating on the griddle.

Overheat Function

This function identifies when the temperature of the pan rises rapidly and works to maintain a safe level of pan temperature. It should not interfere with normal cooking.

Cookware with bases that become distorted when heated may interfere with the operation of the Overheat Function. This may result in damage to your cookware or Induction Glass Hob.

⚠ Please remember not to leave the hob unattended. Care should be taken to not allow your cookware to boil dry. Damage to your cookware and Induction Glass Hob may result.

Please read and follow the manufacturers' instructions carefully before using cookware on your induction hob.

Ceramic Hobs

When cooking on the ceramic hob, a display panel will illuminate to indicate which cook zone is in use (Fig. 3.20).

You may see the hob area you are using switch off and on: this is caused by a safety device that limits the temperature of the hob. This is quite normal, especially when cooking at high temperatures. If it happens a lot with a particular pan, however, it may mean the pan is not suitable – perhaps too small or too uneven – for a ceramic hob.

On the right-hand side of the hob there is a dual purpose area. The inner ring marks the hob zone. The outer area marks the extent of a warmer, which you can use for keeping food warm while the final touches are put to a meal (Fig. 3.20).

Dual element hob plates

The areas marked with two concentric circles have an inner and an outer element (Fig. 3.21). Rotate the control dial clockwise to heat the whole area for larger pans; turn it counter-clockwise to just heat the inner part for smaller pans.

Warming zone and Cooking zone overview

- To use the combined zone, turn the control to the first position (Fig. 3.22).
- The two outer zones may be used as a warming function. The inner zone may be used as a keep warm function. **When using all 3 zones, please ensure that you use heat resistance cookware.**
- To use the dual purpose hob, turn it further to use the inner ring as a normal hob plate.

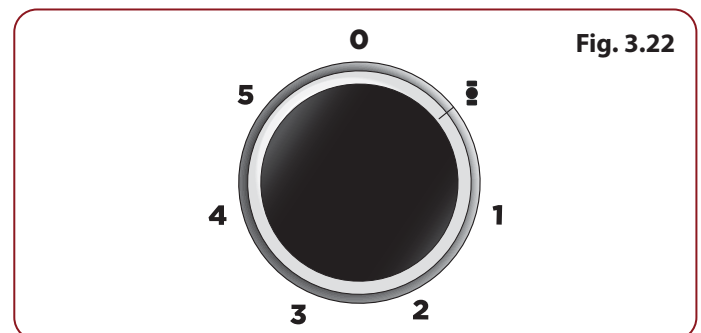
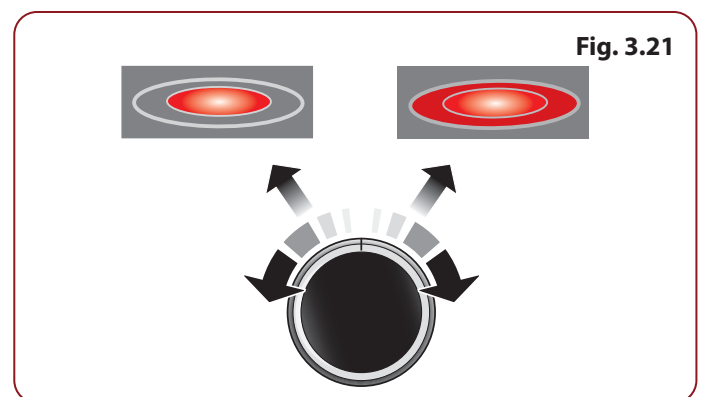
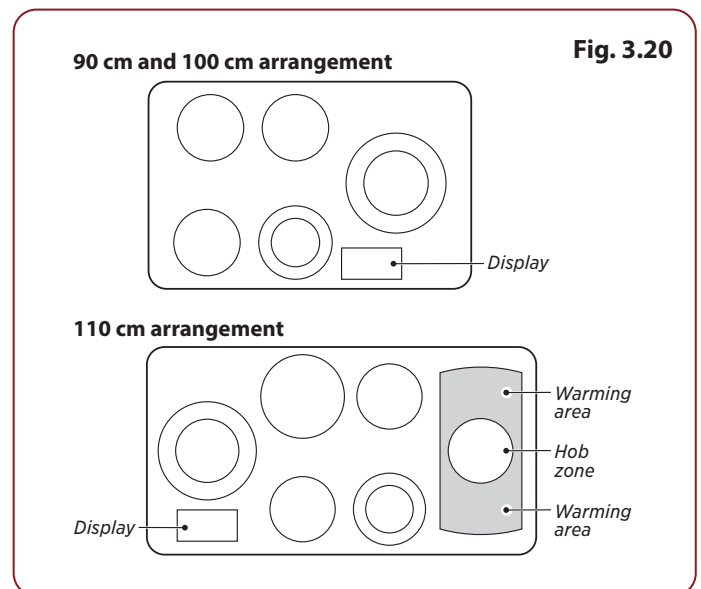

|  | 1 | 2 | 3 | 4 | 5 |
|---|----------------|------------------------------|----------------------|-----------|----------------|
| Complete Warming Zone | Low Level Heat | Medium Heat - melting butter | Medium Heat - simmer | High Heat | Very High Heat |

4. The Grill

Fig. 4.1

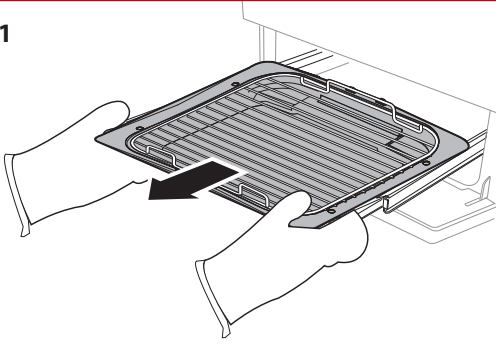

Fig. 4.2

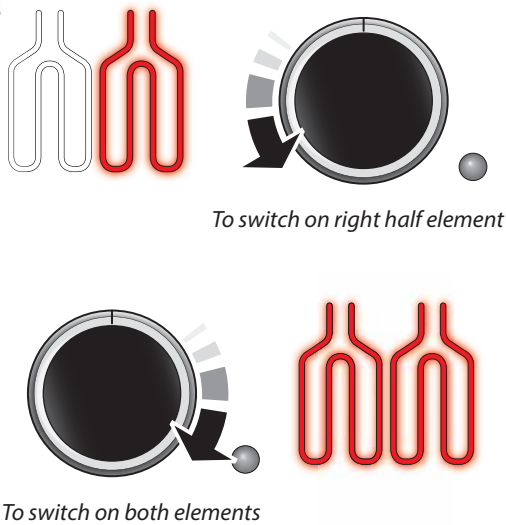

Fig. 4.3

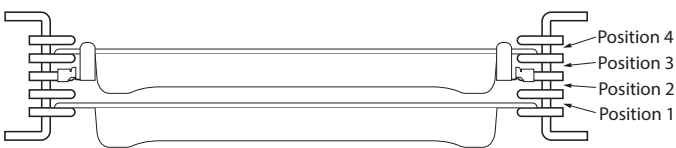

Fig. 4.4

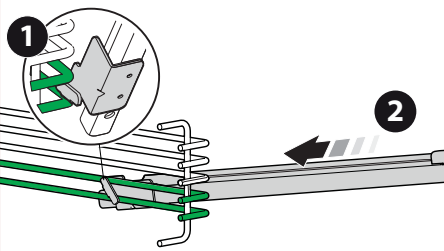
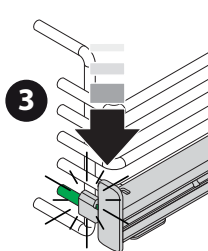

Fig. 4.5



Flexi-grill

Open the door and pull the grill pan carriage forward using oven gloves (**Fig. 4.1**).

The grill has two elements that allow either the whole area of the pan to be heated or just the right-hand half (**Fig. 4.2**).

Adjust the heat to suit by turning the control dial. To heat the whole grill, turn the dial clockwise.

To heat the right-hand half, turn the control dial counter-clockwise. The neon indicator light by the grill control will come on.

For best results, slide the carriage back into the grill chamber. The grill trivet can be removed and the food placed on it while you are waiting for the grill to preheat.

⚠ DO NOT leave the grill on for more than a few moments, without the grill pan underneath it, otherwise the dials may become hot.

Once the grill has preheated, take the grill pan out again and put the trivet back in place with the food on it. Slide the grill pan or carriage back into the grill chamber. Make sure that it is pushed right in.

⚠ Accessible parts may be hot when the grill is in use. Young children should be kept away.

⚠ NEVER close the grill door when the grill is on.

⚠ CAUTION: This appliance is for cooking purposes only. It must not be used for other purposes, for example room heating.

⚠ WARNING: When the trivet has been removed from the grill pan, please ensure that the grill pan and cradle are fully returned into the grill chamber.

Positioning the Grill

The grill pan can be positioned on 4 levels (positions 1 - 4). If using the runners this is reduced to 3 levels (positions 2 - 4) (**Fig. 4.3**).

Fitting the Telescopic Runners

Slide the telescopic runners onto the selected ladders and clip them securely in place. (**Fig. 4.4** and **Fig. 4.5**)

Grill Trivet Height Adjustment

The grill trivet has 4 different height positions (**Fig. 4.6**).

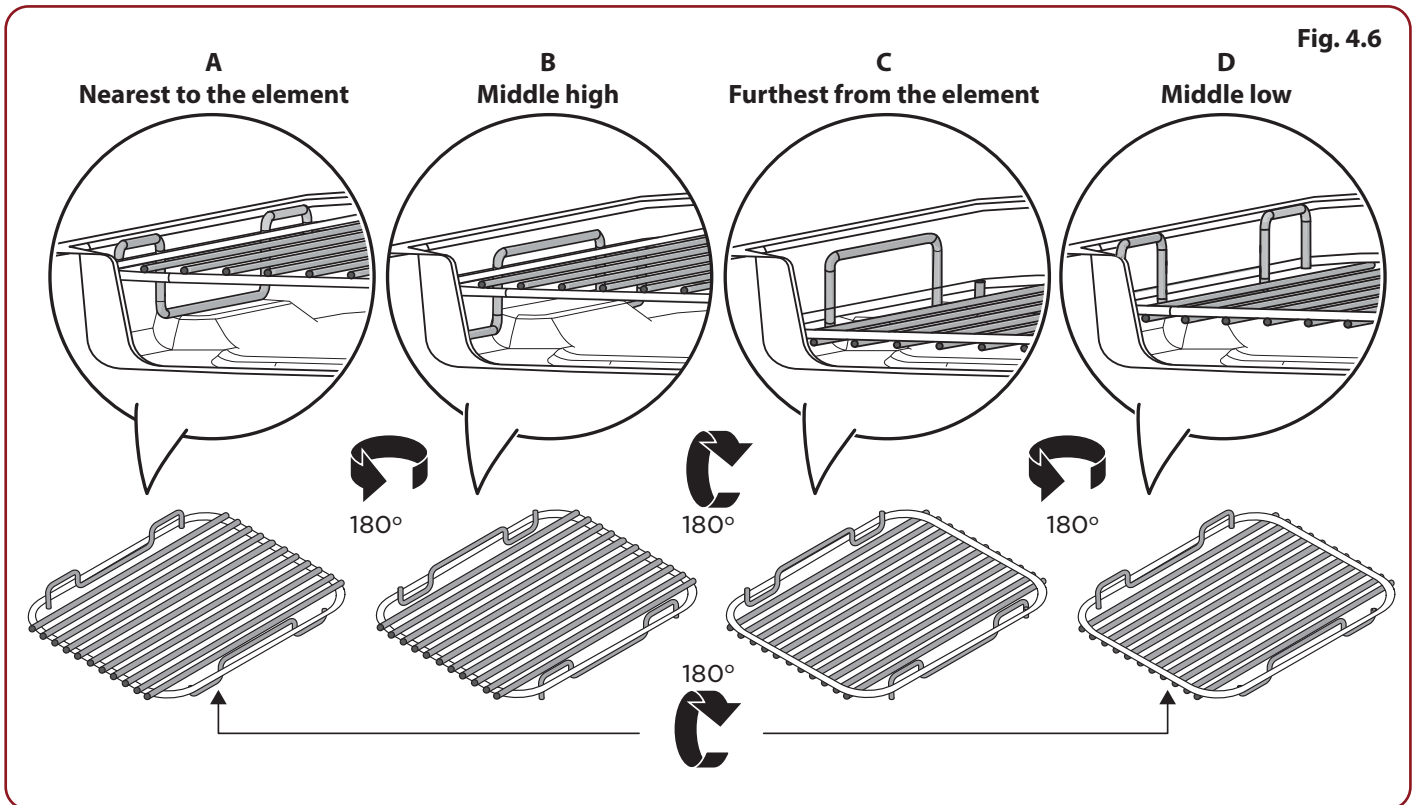

Cooking suggestions

1. Nearest to the element – Toast, streaky bacon.
2. Middle high – cheese on toast, welsh rarebit, courgette slices, back bacon.
3. Middle low – fish fillets, vegetable skewers.
4. Furthest from the element – whole fish, thick pork chops, chicken breasts, chicken or beef skewers.

NOTE: A short term cooking process has to be supervised continuously.

Fitting the Grill Pan

Align the 4 holes on the grill pan to the 4 locating pins of the telescopic runners (**Fig. 4.7**), or slide the grill pan directly onto the ladder using Position 1 (**Fig. 4.3**).

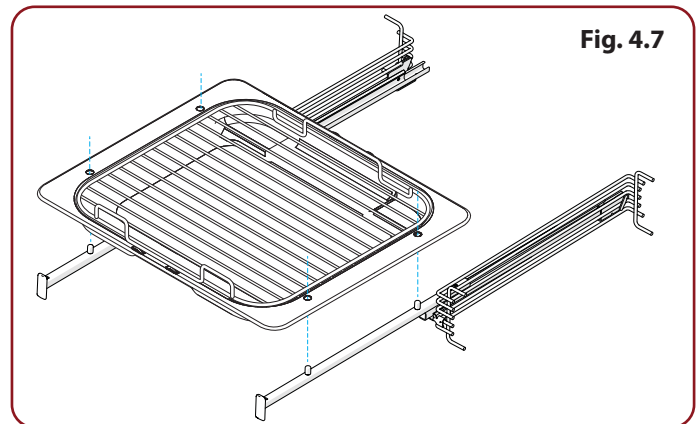

| Function | Use |
|-------------------|---|
| Defrost | To thaw small items in the oven without heat |
| Fan oven | A full cooking function, even heat throughout, great for baking |
| Fanned grilling | Grilling meat and fish with the door closed |
| Fan assisted | A full cooking function good for roasting and baking |
| Conventional oven | A full cooking function for roasting and baking in the lower half of the oven |
| Browning element | To brown and crisp cheese topped dishes |
| Base heat | To crisp up the bases of quiche, pizza or pastry |

Table 5.1

5. The Ovens

The clock must be set to the time of day before the ovens will work. See the section on **“Set your Clock” on page 7** for instructions on setting the time of day.

References to ‘left-hand’ and ‘right-hand’ ovens apply as viewed from the front of the appliance.

Multifunction Oven

As well as the oven fan and fan element, multifunction ovens are fitted with two extra heating elements, one visible in the top of the oven and the second under the oven base. Take care to avoid touching the top element and element deflector when placing or removing items from the ovens.

The multifunction oven has **3 main cooking functions: fan, fan assisted and conventional cooking**. These functions should be used to complete most of your cooking.

The **browning element** and **base heat** can be used in the latter part of the cooking process to fine tune the results to your particular requirements.

Use **fanned grilling** for all your grilling needs and **defrost** to safely thaw small items of frozen food.

Table 5.1 gives a summary of the multifunction modes.

- The multifunction ovens have many varied uses. We suggest you keep a careful eye on your cooking until you are familiar with each function. Remember – not all functions will be suitable for all food types.
- Please remember that all cookers vary – temperatures in your new ovens may differ to those in your previous cooker.

Oven functions

The multifunction ovens have various functions. Remember that not all functions will be suitable for all food types.



Duo

The Duo mode operates the fan and heating element around the fan to produce an even heat to cook the food, while also utilising the base element to perfectly cook and crisp the base. Use the bottom shelf position (shelf position 1) when using this function.



Fan Oven

This function operates the fan and the heating element around it. An even heat is produced throughout the oven, allowing you to cook on multiple shelf positions at one time. This function is a good 'all-round' function.



Fanned Grilling

This closed-door grilling function operates the fan whilst the top element is on. This is a more even, less intense heat than a conventional grill. The food should be placed on a grill pan and trivet, as this allows greater air circulation, and the grill pan should not be located on the highest shelf position.



Fan Assisted Oven

This function operates the fan, circulating air heated by the elements at the top and the base of the oven. The combination of fan and conventional cooking (top and base heat) makes this function ideal for roasting large meat roast.



Conventional Oven (Top and Base Heat)

Conventional is going back to traditional method of cooking, the heat from the top and base elements combines. As no fan is used there is no drying effect on food, making this an ideal function for any cooking or baking in the oven for longer than 1½ hours. Only recommended for cooking on 1 shelf, ensuring the food is as close to the centre of the oven as possible.



Browning Element

This function uses the element in the top of the oven only. It is useful for the browning or finishing off dishes.



Base Heat

This function uses the base element. It is a gentle heat good for slow cooking and bain-marie cooking.



Defrost

This function operates the fan to circulate cold air only. Defrosting in this way speeds up the process and protects the food. Large items, such as whole chickens and joints should not be defrosted in this way. Defrosting should not be carried out in a warm oven or when an adjoining oven is in use or still warm.



Bread Proving Drawer

The Bread Proving Drawer temperature is ideal for proving all types of yeast dough.

Preheat the Bread Proving Drawer

It is operated by a push button. There is no need to set the temperature, this is already set.

The time needed for proving will depend upon the dough type and the amount. Refer to the recipe for guidance and check the dough during the proving time.

Keep an eye on the dough while it is proving; fresh yeast can work quickly especially if it has had a first fermentation stage (sometimes called sponging). Sponging can help produce a slightly lighter loaf.



Slow Cook Oven

The Slow Cook oven is intended for slow cooking, keeping warm or warming plates and serving dishes.

Fig. 5.1

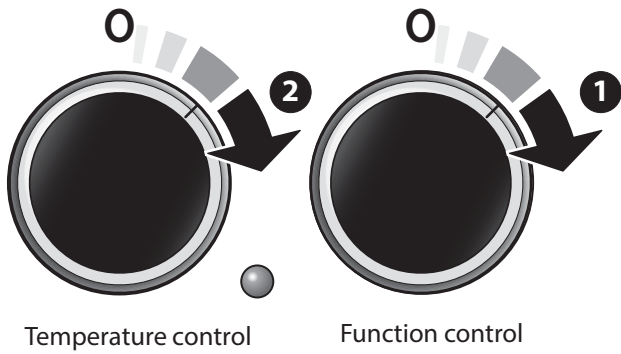

Operating the Multifunction Oven

The multifunction oven has two controls: a function selector and a temperature setting dial (Fig. 5.1).

Turn the function selector control to a cooking function. Turn the oven temperature dial to the temperature required.

The oven heating light will glow until the oven has reached the temperature you selected. It will then cycle on and off during cooking as the oven maintains the selected temperature.

Fan Oven

Fan ovens circulate hot air continuously, which means faster, more even cooking.

The recommended cooking temperatures for a fan oven are generally lower than a conventional oven.

* **Note:** Please remember that all cookers vary so temperatures in your new ovens may differ to those in your previous cooker.

Operating the Fan Oven

Turn the oven dial to the desired temperature (Fig. 5.2).

The oven indicator light will glow until the oven has reached the temperature selected. It will then cycle on and off during cooking.

Fig. 5.2

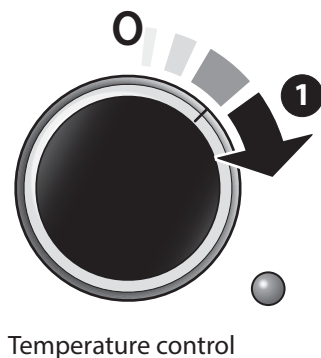

Bread Proving Drawer

The Bread Proving Drawer is found on the right at the base of the cooker (**Fig. 5.3**).

The Bread Proving Drawer temperature is ideal for proving all sorts of yeast dough from sweet to savoury, gluten free to sourdough, dough made from fresh yeast and dried, bread mixes and recipes.

The Bread Proving Drawer can be used for storage. If you have used the Bread Proving Drawer, switch it off and wait until the drawer cools before storing any items.

NOTE: The Bread Proving Drawer will not warm plates

Preheat the Bread Proving Drawer

It is operated by a push button. There is no need to set the temperature, this is already set.

The Bread Proving Drawer has space for:

- Baking trays, no larger than 340mm x 340mm, to prove bread rolls or buns; these can then be put straight into a preheated oven after proving.
- 3 litre bowl full of dough
- 3 x 2 pound loaf tins
- 4 x 1 pound loaf tins

The time needed for proving will depend upon the dough type and the amount. Refer to the recipe for guidance and check the dough during the proving time.

If a large baking tray is used, place a cooling rack on to the base of the drawer, and put the tray on top, this will allow the warmed air to reach the dough.

When preparing larger quantities of yeast dough, containing 500g or over of flour, divide the dough into 2 bowls or containers, this will make proving in the drawer easier.

Keep an eye on the dough while it is proving; fresh yeast can work quickly especially if it has had a first fermentation stage (sometimes called sponging). Sponging can help produce a slightly lighter loaf.

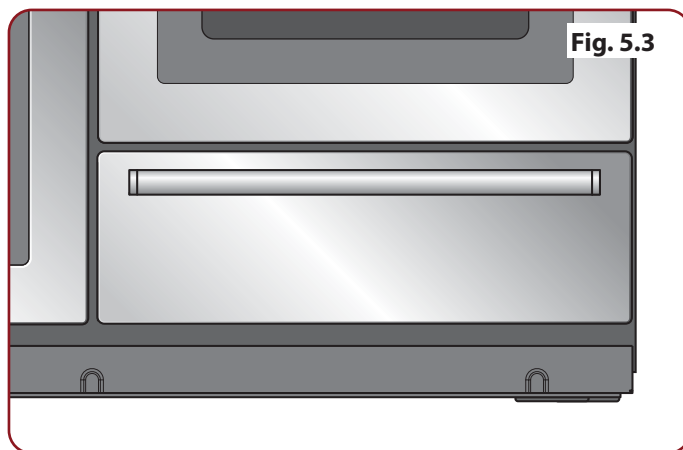

TOP TIPS

Not sure of the capacity of your loaf tins?

- A one pound loaf tin will hold 800ml of water
- A two pound loaf tin will hold 1.5 litres of water.
- Cover the dough while it is proving with greased cling film, be careful not to anchor the cling film too tightly so that it prevents the dough from rising.

Fig. 5.4

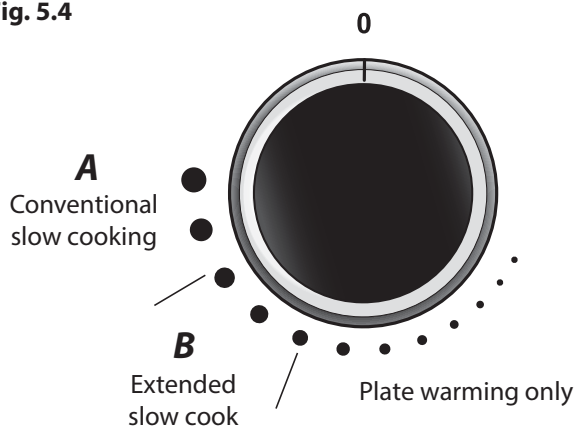

The Slow Cook Oven

The Slow Cook oven is intended for slow cooking items such as casseroles, joints of meat, etc. It is capable of cooking a complete meal; for instance – casserole, rice pudding and jacket potatoes – or just warming the dishes (use only heat resistant dishes).

It is also useful for warming plates and serving dishes (use only heat resistant types).

- We do not recommend warming fine bone china crockery.

Operate the Slow Cook Oven

The graduated temperature scale on the fascia allows you to either cook slowly for several hours (**A**) or all day whilst you are out (**B**) (**Fig. 5.4**).

Points to remember when Slow Cooking

- Preheat the oven for 20–30 minutes before starting to cook.
- Do not allow dishes to touch the heating elements either side of the oven.
- Bring casseroles, soups etc to the boil on the hob before placing into a suitable casserole for slow cooking.
- Make sure that casseroles have sufficient liquid, particularly when cooking over a long period.
- Use lids on casseroles or foil to cover food whilst it is cooking to retain moisture.
- Make sure all dishes will fit into the oven before preparing the food.
- Wrap washed and pricked jacket potatoes in foil before cooking.
- Make sure that meat and poultry reach a safe temperature of at least 90°C before eating.
- Always thaw frozen food completely before cooking.
- You can cook a fruitcake in the Slow Cook on the maximum heat setting (if perhaps your other ovens are in use). If you are using the fan oven below the Slow Cook at the same time allow a little more cooking time.
- You can also produce crisp, white meringues cooked in the Slow Cook.
- Timings for cooking in the Slow Cook will depend upon the temperature, quantity and type of dish you are cooking, as a guide for casseroles, a minimum of 3 hours cooking time is recommended.
- Keep an eye on the food until you are familiar with the oven.

Oven Shelves

The oven shelves (**Fig. 5.12**) are retained when pulled forward but can be easily removed and refitted.

Pull the shelf forward until the back of the shelf is stopped by the shelf stop bumps in the oven sides (**Fig. 5.13**).

Lift up the front of the shelf so the back of the shelf will pass under the shelf stop and then pull the shelf forward (**Fig. 5.14** and **Fig. 5.15**).

To refit the shelf, line up the shelf with a groove in the oven side and push the shelf back until the ends hit the shelf stop. Lift up the front so the shelf ends clear the shelf stops, and then lower the front so that the shelf is level and push it fully back.

The Handyrack

The Handyrack fits to the left-hand oven door only (**Fig. 5.16**). Food cooking on it is easy to attend to, because it is accessible when the door is open.

The maximum weight that can be held by the Handyrack is 5.5 kg (12 lb). It should only be used with the supplied roasting tin, which is designed to fit the Handyrack. Any other vessel could be unstable.

It can be fitted at two different heights. One of the oven shelves must be removed and the other positioned to suit.

When the Handyrack is used in its highest position, other dishes can be cooked on the bottom shelf position or base of the oven. When the Handyrack is used in its lowest position, other dishes can be cooked on the second shelf position or base of the oven.

To fit the Handyrack, locate one side of it on the door bracket. Then spring the other side out to clip it onto the other bracket (**Fig. 5.17**).

Oven Shelves – Right-hand (Tall) Oven

The tall oven is supplied with four flat cooking shelves and a plate-warming shelf (**Fig. 5.18**).

When using the tall oven, you can cook on all four shelves at the same time (**Fig. 5.19**), but make sure that they are well spaced out allow the hot air to circulate.

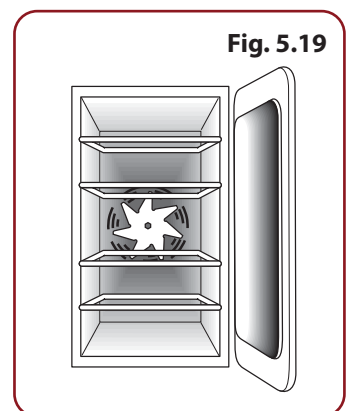
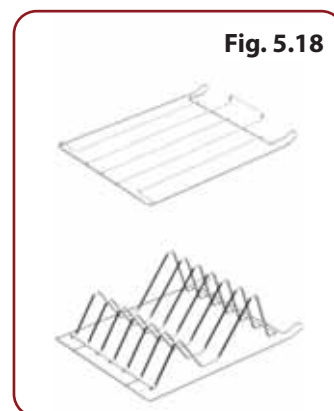
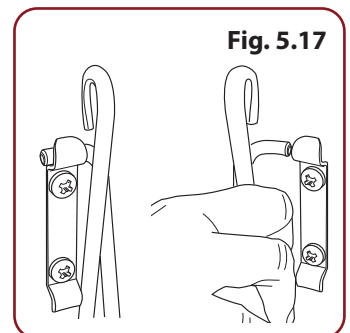
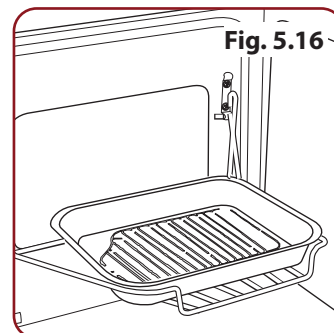
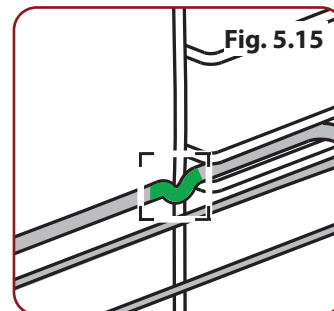
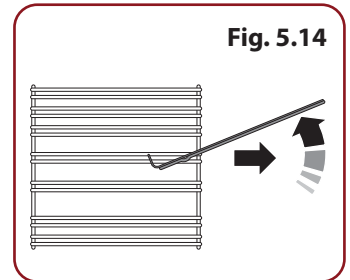
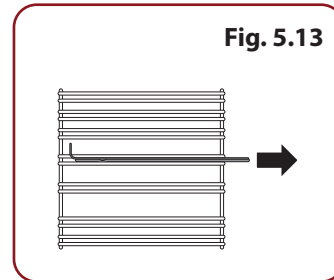
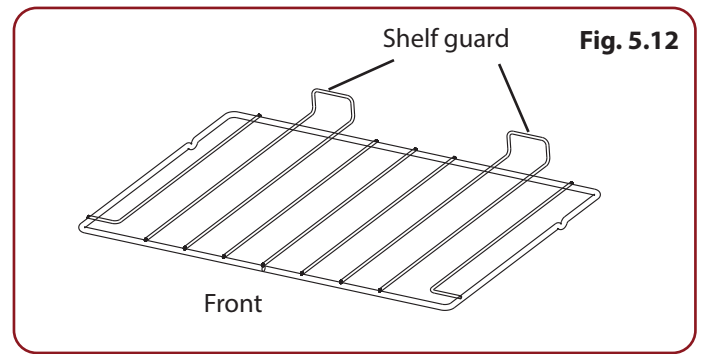
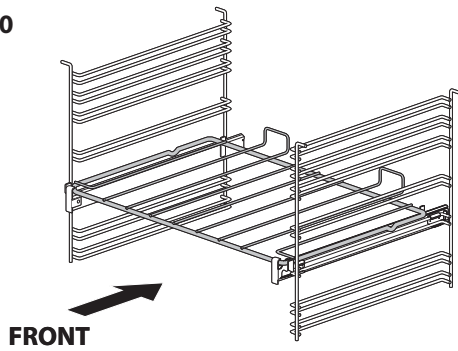

Fig. 5.20



Glide-out Oven Shelf

Glide-out oven shelves are available for all ovens except the tall oven.

Note: The Handyrack must be removed before fitting the glide-out shelf.

The rungs on the shelf supports are in pairs. The glide-out shelf runners can be fitted to any pair except the top pair (Fig. 5.20).

To fit the glide-out shelf runners

Hook the rear of the runner over the top rung of a pair of shelf supports. Then hook the front of the runner onto the same rung. Push to clip under the bottom rung (Fig. 5.21).

The front of the shelf runners can be identified by the bracket.

Ensure that the shelf runners are fitted in the same position on each side (Fig. 5.22).

To fit the glide-out shelf

Check the shelf runners are secure before fitting the glide-out shelf.

Hook the front of the glide-out oven shelf onto the runners as shown. The rear of the shelf should rest on the runners, in front of the rear stop (Fig. 5.23).

Ensure that the shelf sits flat once in position.

⚠ DO NOT put the glide-out shelf runners in a dishwasher

Fig. 5.21

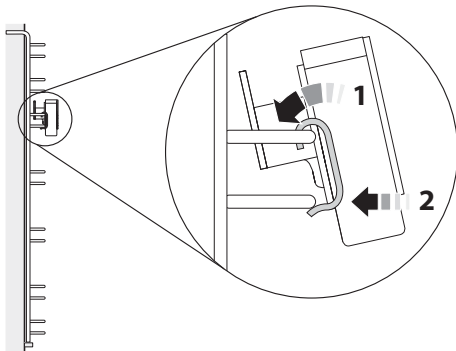

Fig. 5.22

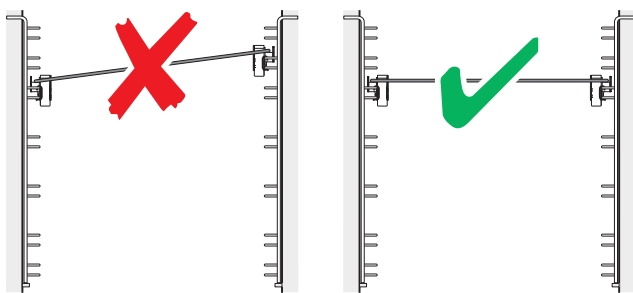
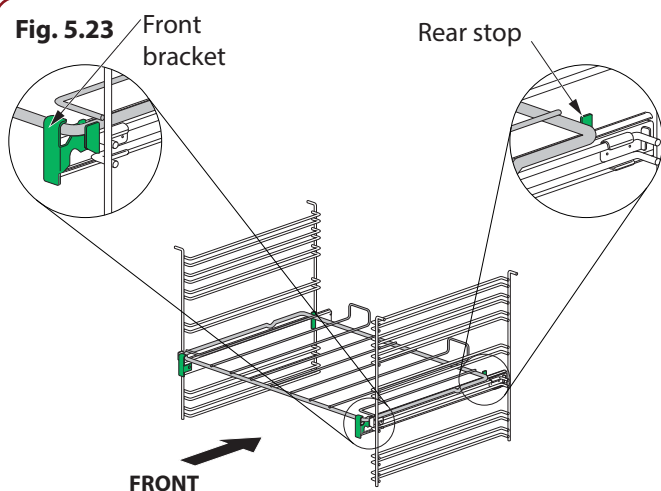

Fig. 5.23



Multifunctional Oven in Single Cavity

Energy Saving Panel

For single cavity oven, you can use the supplied energy saving panel and tuck the rubber seal along the inner glass edge (**Fig. 5.24**) to perform its multifunctional features. Half of the oven is heated and only the right-hand side elements are used. This saves energy and is ideal for cooking most foods. When using the divider, condensation may appear in the left-hand oven – this is normal.

For very large loads, or large dishes for special occasions then the divider can be removed. This brings into use the elements on the left-hand side as well as those on the right when a function is selected.

All oven functions are available in full and divided forms and shelves are provided for use in both forms.

Warning!
Take great care when removing the divider not to scratch the inner glass door surface. Scratches in the glass can cause stress and may cause the door to fail.

Removing the Energy Saving Panel

Warning! Make sure the cooker is cool before attempting to remove the panel.

Fully open the door and remove the rubber seal and oven shelves. When removing the divider, lift it slightly upwards, grip the underside to prevent the metal base making contact with the door glass, and slide it out (**Fig. 5.25**).

We recommend that you place a tea towel or similar on the door glass before removing the divider. This should prevent the door inner from scratching.

DO NOT place or slide metallic objects, including cookware, on the door glass as this may cause scratching and subsequent failure to occur.

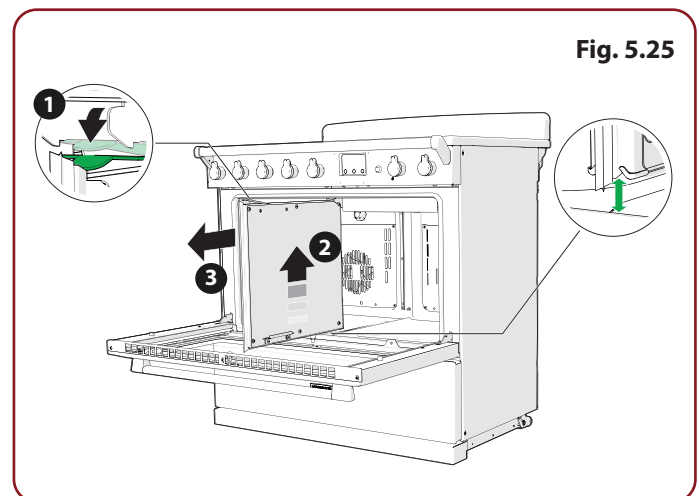
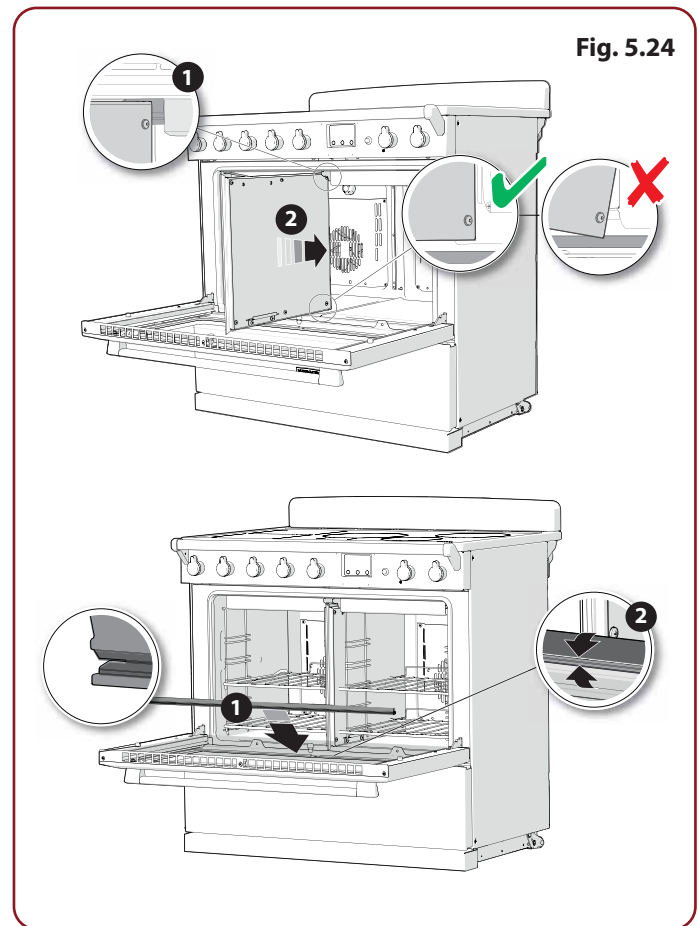

6. Cooking Tables

- The cooking times and temperatures in these tables are a guide only always ensure that foods, especially meats and poultry, are fully cooked through.

Shelf positions

- Unless otherwise stated when cooking on one shelf position aim for the food to be in the centre of the oven. For cooking on 2 or more shelf positions, aim to place the food equidistance apart, to allow air flow.
- Image of shelf positions being counted from the bottom up.

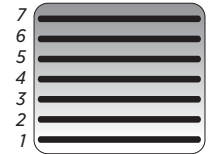

Oven Shelf Positions

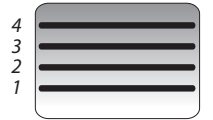

Grill Shelf Positions

Multifunction Oven - Conventional

Meats & Poultry

| Food | Oven Function | Shelf Position | Temperature (°C °F) | Degree of Doneness | Time |
|----------------|---------------|----------------|-----------------------|--------------------|-----------------------------------|
| Beef (no bone) | Conventional | 3 | 180 355 | Rare | 40 minutes per kg plus 20 minutes |
| | | | | Medium | 50 minutes per kg plus 20 minutes |
| | | | | Well Done | 60 minutes per kg plus 20 minutes |
| Lamb | Conventional | 3 | 180 355 | Medium | 50 minutes per kg plus 20 minutes |
| | | | | Well Done | 60 minutes per kg plus 20 minutes |
| Pork | Conventional | 3 | 180 355 | - | 70 minutes per kg plus 35 minutes |
| Roast Chicken | Conventional | 3 | 200 390 | - | 45 minutes per kg plus 20 minutes |
| Turkey (Whole) | Conventional | 3 | 190 375 | - | 40 minutes per kg plus 90 minutes |
| Duck | Conventional | 3 | 200 395 | - | 40 minutes per kg plus 10 minutes |

Main Dishes, Sides and Extras

| Food | Oven Function | Shelf Position | Temperature (°C °F) | Time |
|-----------|---------------|----------------|-----------------------|------------------|
| Casserole | Fan | 3 | 140 285 | At least 3 hours |

Cakes

| Food | Oven Function | Shelf Position | Temperature (°C °F) | Time |
|--|---------------|----------------|-----------------------|--------------------------------|
| Rich Fruit cake | Conventional | 2 | 160 320 | 45-50 minutes per 500g mixture |
| Farmhouse / Semi rich fruit cake (200mm tin) | Conventional | 2 | 160 320 | 2 - 2 ½ hours |
| Madeira Cake (2lb loaf tin) | Conventional | 2 | 170 340 | 80-90 minutes |

Bread

| Food | Oven Function | Shelf Position | Temperature (°C °F) | Time |
|----------------------------------|---------------|----------------|---|---------------|
| Bread Loaf (2lb loaf tin) | Conventional | 3 | 220 430 (initial) 190 375 (after 15 minutes) | 45 minutes |
| Bread Rolls (80g balls of dough) | Conventional | 3 | 220 430 | 15-20 minutes |
| Focaccia / Flat bread | Conventional | 3 | 220 430 | 20 minutes |

* Preheat baking tray with oven

Multifunctional Oven - Duo

Baked goods

| Food (25 cm flan dish) | Oven Function | Shelf Position | Temperature (°C °F) | Time |
|------------------------|---------------|----------------|-----------------------|---------------|
| Bakewell Tart | Duo | 1 | 170 340 | 35-40 minutes |
| Lemon Meringue Pie | Duo | 1 | 180 355 | 35-40 minutes |
| Quiche | Duo | 1 | 170 340 | 30-35 minutes |

Bread

| Food | Oven Function | Shelf Position | Temperature (°C °F) | Time |
|------------------------------|---------------|----------------|-----------------------|-------------|
| Pizza (200g fresh raw dough) | Duo | Floor of oven | 210 410 | 5-8 minutes |

Multifunctional Oven - Fan Assisted

Meats and Poultry

| Food | Oven Function | Shelf Position | Temperature (°C °F) | Degree of Doneness | Time |
|----------------|---------------|----------------|-----------------------|--------------------|-----------------------------------|
| Beef (no bone) | Fan Assisted | 3 or 4 | 180 355 | Rare | 40 minutes per kg plus 20 minutes |
| | | | | Medium | 50 minutes per kg plus 20 minutes |
| | | | | Well Done | 60 minutes per kg plus 20 minutes |
| Lamb | Fan Assisted | 3 or 4 | 180 355 | Medium | 50 minutes per kg plus 20 minutes |
| | | | | Well Done | 60 minutes per kg plus 20 minutes |
| Pork | Fan Assisted | 3 or 4 | 180 355 | - | 70 minutes per kg plus 35 minutes |
| Roast Chicken | Fan Assisted | 3 or 4 | 200 390 | - | 45 minutes per kg plus 20 minutes |
| Turkey (Whole) | Fan Assisted | 3 or 4 | 190 375 | - | 40 minutes per kg plus 90 minutes |
| Duck | Fan Assisted | 3 or 4 | 200 395 | - | 40 minutes per kg plus 10 minutes |

Main Dishes, Sides and Extras

| Food | Oven Function | Shelf Position | Temperature (°C °F) | Time |
|-------------------------------------|---------------|----------------|-----------------------|--------------------------------|
| Nut Roast (2lb loaf tin) | Fan Assisted | 4 | 160 320 | 45-50 minutes |
| Vegetarian Wellington | Fan Assisted | 4 | 190 375 | 35-40 minutes |
| Yorkshire Pudding (12 hole bun tin) | Fan Assisted | 4 | 210 410 | 30 minutes plus oil preheat |
| Roast Potatoes | Fan Assisted | 3 | 200 395 | 60-70 minutes plus oil preheat |

Multifunctional Oven - Base Heat

Slow cooking

| Food | Oven Function | Shelf Position | Temperature (°C °F) | Time |
|-----------|---------------|----------------|-----------------------|------------------|
| Casserole | Base Heat | 1 | 140 285 | At least 3 hours |

Bain-Marie

| Food | Oven Function | Shelf Position | Temperature (°C °F) | Time |
|------------------------------|---------------|----------------|-----------------------|---------------|
| Crème Brûlée (10cm ramekins) | Base Heat | 1 | 150 300 | 35-40 minutes |

Grill Cavity

Bread products

| Food | Grill Power Level | Trivet Position | Shelf Position | Time |
|-----------------------|-------------------|-----------------|----------------|------|
| Toast | 3 | | | |
| Tea Cakes/Fruit Bread | 3 | | | |
| Cheese on Toast | 3* | | | |

Meats

| Food | Grill Power Level | Trivet Position | Shelf Position | Degree of Doneness | Time |
|------------------------------|-------------------|-----------------|----------------|--------------------|------|
| Beef Steak (Sirloin) | 3 | | | Rare | |
| | | | | Medium | |
| | | | | Well Done | |
| Bacon | 3 | | | | |
| Sausage | 3 | | | | |
| Chicken Breast (Butterflied) | 2 | | | | |

Vegetables

| Food | Grill Power Level | Trivet Position | Shelf Position | Time |
|-------------------|-------------------|-----------------|----------------|------|
| Vegetable skewers | 3 | | | |
| Mushrooms | 2 | | | |
| Sweetcorn | 1 | | | |
| Asparagus | 2 | | | |

Bread Proving Drawer

| Food | Stage | Status | Time |
|-----------------------------|--------------|-----------------|-----------------|
| White bread dough | First prove | In mixing bowl | 40 – 45 minutes |
| | | In 2lb loaf tin | 25 – 30 minutes |
| | Second prove | Free form loaf | 15 – 20 minutes |
| | | 80g bread rolls | 25 – 30 minutes |
| Seeded or granary dough | First prove | In mixing bowl | 50 – 60 minutes |
| | | In 2lb loaf tin | 40 - 45 minutes |
| | Second prove | Free form loaf | 30 - 35 minutes |
| | | 80g bread rolls | 30 – 35 minutes |
| Wholemeal dough (1st prove) | First prove | In mixing bowl | 1 – 1¼ hours |
| | | In 2lb loaf tin | 45- 50 minutes |
| | Second prove | Free form loaf | 40 – 45 minutes |
| | | 80g bread rolls | 40 – 45 minutes |
| Enriched dough (1st prove) | First prove | In mixing bowl | 2-3 hours |
| | Second prove | In 2lb loaf tin | 1-2 Hours |

Slow Cook Cavity

| Food | Shelf Position | Temperature (°C °F) | Time |
|---------------|----------------|-----------------------|------------------|
| Casserole | Base of oven | Max | At least 6 hours |
| 2kg Chicken | Base of oven | Max | At least 8 hours |
| Joint of pork | Base of oven | Max | At least 6 hours |

Dual Fuel - Hotplate

Burners

| Burner Name | Cookware | Uses |
|-------------|--|--|
| Wok | Wok Large jam pan Large base hob top kettles Paella pan | Stir fry, fried rice Jam, marmalade, chutney Boiling water Paella and risottos |
| Rapid | Large saucepans Hob top steamers Large frying pans Griddle pans | Boiling water for pasta, rice, vegetables etc Making curry, pasta sauces, stews etc Vegetables, fish, meats, steamed puddings, dim sum. Frying meats and eggs Frying of meats and vegetables |
| Semi-Rapid | Medium saucepan | Sauce making |
| Aux | Milk pans* Espresso maker* | Heating milk and ready made sauces. Coffee making |

*Milk pan spacer

Induction

| Power Level | Heat | Temperature (°C °F) | Uses |
|-------------|-------------|-----------------------|---|
| L1 | Preset | 40 104 | Melting chocolate and butter |
| L2 | | 70/90 158/194 | Keep warm/ Simmering (depending on model) |
| L3 | | 90 194 | Simmering (depending on model) |
| L1-3 | Low heat | | Warming, melting, sauce (eggs based) and custard making |
| L4-6 | Medium heat | | Simmering, sauce (flour and tomato based) making, sauté |
| L7-9 | High heat | | Frying, boiling, deep frying |

Test House Test Dishes

These tables have been produced for test institutes to facilitate appliance testing. As per EN 60350-1.

Fanned oven

| Food | Oven Function | Shelf Position | Temperature (°C °F) | Time |
|---------------------------|---------------|----------------|-----------------------|------------|
| Shortbread, 1 shelf | Fan | 3 | 180* 356* | 12 minutes |
| Shortbread, 2 shelves | Fan | 2 and 4 | 180* 356* | 12 minutes |
| Shortbread, 3 shelves | Fan | 1, 3 and 5 | 180* 356* | 12 minutes |
| Small Cakes, 1 shelf | Fan | 3 | 160* 320* | 30 minutes |
| Small Cakes, 2 shelves | Fan | 2 and 4 | 160* 320* | 30 minutes |
| Small cakes, 3 shelves | Fan | 1, 3 and 5 | 160* 320* | 30 minutes |
| Fatless Sponge, 1 shelf | Fan | 3 | 180* 356* | 35 minutes |
| Fatless Sponge, 2 shelves | Fan | 2 and 4 | 180* 356* | 35 minutes |

*Preheated

Grill Cavity

| Food | Grill Power Level | Trivet Position | Shelf Position | Time |
|--------------|-------------------|-----------------|----------------|-------------|
| Toast | 3* | | 3 | 3-4 minutes |
| Beef Burgers | 3* | | 2 | 15 minutes |

*Preheated for 3 minutes.

Fan Oven

Meats & Poultry

| Food | Shelf Position | Temperature (°C °F) | Degree of Doneness | Time |
|----------------|----------------|-----------------------|--------------------|-----------------------------------|
| Beef (no bone) | 3 | 160 320 | Rare | 40 minutes per kg plus 20 minutes |
| | | | Medium | 50 minutes per kg plus 20 minutes |
| | | | Well Done | 60 minutes per kg plus 20 minutes |
| Lamb | 3 | 160 320 | Medium | 50 minutes per kg plus 20 minutes |
| | | | Well Done | 60 minutes per kg plus 20 minutes |
| Pork | 3 | 160 320 | - - | 70 minutes per kg plus 35 minutes |
| Roast Chicken | 3 | 180 355 | - - | 45 minutes per kg plus 20 minutes |
| Turkey (Whole) | 3 | 170 340 | - - | 40 minutes per kg plus 90 minutes |
| Duck | 3 | 180 355 | - - | 40 minutes per kg plus 10 minutes |
| Sausages | | 180 355 | - - | |

Fish

| Food | Oven Function | Shelf Position | Temperature (°C °F) | Time |
|--------|---------------|----------------|-----------------------|-------------------------|
| Fillet | Fan Grill | 3 | 190 375 | 15-20 minutes |
| Whole | Fan Grill | 3 | 180 355 | 15-20 minutes per 500g* |

Main Dishes, Sides and Extra

| Food | Shelf Position | Temperature (°C °F) | Time |
|--|----------------|-----------------------|--------------------------------|
| Yorkshire Pudding (12 hole bun tin) | 4 | 210 410 | 30 minutes plus oil preheat |
| Roast Potatoes | 3 | 200 390 | 60-70 minutes plus oil preheat |
| Casserole | 3 | 140 285 | At least 2 hours |
| Lasagne/Cottage pie (30cm x 21cm baking dish) | 3 | 180 355 | 40 – 45 minutes |
| Meat Pie (Pastry only on top) (30cm x 21cm baking dish) | 4 | 200 390 | 30-35 minutes |
| Pizza (shop brought – chilled) | 4 | 200 390 | 10 – 12 minutes |

Cakes

| Food | Shelf Position | Temperature (°C °F) | Time |
|--|----------------|-----------------------|--------------------------------|
| Rich Fruit cake | 2 | 140 285 | 45-50 minutes per 500g mixture |
| Farmhouse / Semi rich fruit cake (200mm tin) | 2 | 140 285 | 2 -2½ Hours |
| Madeira Cake (2lb loaf tin) | 2 | 150 300 | 80-90 minutes |
| Victoria Sandwich (210mm tins) | | 160 320 | 30-35 minutes |
| Fairy Cakes | | 160 320 | 30-35 minutes |
| Cupcakes (12 hole bun tin) | | 170 340 | 20-25 minutes |

Desserts

| Food | Shelf Position | Temperature (°C °F) | Time |
|--|----------------|-----------------------|--|
| Choux pastry (2cm profiteroles) | 3 | 210 410 | 15-20 minutes |
| Scones | 3 | 200 390 | 12-15 minutes |
| Meringues (7cm nests) | 3 | 100 210 | 4 hours |
| Puff Pastry | 3 | 200 410 | 15-20 minutes |
| Fruit Pies (23cm pie Dish) | 3 | 200 390 | 30-35 minutes |
| Bakewell Tart (25cm flan tin) | 3 | 170 340 | 20 minutes to blind bake then 40-45 minutes with filling |
| Bread and Butter Pudding (30cm x 21cm baking dish) | 3 | 170 340 | 40-45 minutes |
| Fruit Crumble (30cm x 21cm baking dish) | 3 | 180 355 | 30-35 minutes |

Bread

| Food | Shelf Position | Temperature (°C °F) | Time |
|----------------------------------|----------------|---|-----------------|
| Pizza (Fresh raw dough) | Floor of oven | 210* 410* | 8-10 minutes |
| Bread loaf (2lb Tin) | 3 | 200 410 reduced to 170 340 after 15 minutes | 45 minutes |
| Bread Rolls (80g balls of dough) | 3 | 200 390 | 15 - 20 minutes |
| Focaccia / Flat Breads | 3 | 200 390 | 20 minutes |

* Preheated

7. Cooking Tips

Fan and Multifunction Oven

| Topic | Recommendation |
|-------------------------------------|---|
| Cooking on multiple shelf positions | <ul style="list-style-type: none">• Always use the fanned function.• Check the maximum tray sizes to be used for the most even heat distribution:-<ul style="list-style-type: none">• Left hand cavity (all models) 340 x 340(mm)• 90cm Tall Oven 320 x 230(mm)• 100cm Tall Oven |
| Preheat the oven | <ul style="list-style-type: none">• If you wish to preheat the oven, wait until the oven indicator has gone out before inserting the food. |
| Insert the wire shelves | <ul style="list-style-type: none">• Make sure to push firmly to the back of the oven. |
| Allow heat to circulate | <ul style="list-style-type: none">• Always leave a “finger’s width” between dishes on the same shelf. This allows the heat to circulate freely around them. |
| Meat roasting | <ul style="list-style-type: none">• Allow meat to come up to room temperature before roasting.• Allow the meat to rest for between half and the full cooking time. |

Bread Proving

| Topic | Recommendation |
|-----------------------|--|
| Prove the bread dough | <ul style="list-style-type: none">• Cover the dough while it is proving with greased cling film. |

Slow Cook

| Topic | Recommendation |
|---|---|
| Preheat the slow cook | <ul style="list-style-type: none">• Preheat the slow cook oven for 20-30 minutes before starting to cook. |
| Spacing between dishes and the heating elements | <ul style="list-style-type: none">• Do not allow dishes to touch the heating elements on either side of the oven.• For best results, boil on the hob before placing into a suitable casserole for slow cooking. |
| Cook casseroles, soup, etc | <ul style="list-style-type: none">• Make sure that casseroles have sufficient liquid, particularly when cooking over a long period.• Use lids on casseroles or foil to cover food whilst it is cooking to retain moisture. |

8. Cleaning Table

- Allow the cooker to cool down before carrying out any cleaning. For major cleaning isolate the electricity supply.
- Regular cleaning is recommended. For easier cleaning wipe up any spillages immediately.
- For enameled surfaces use a cleaner that is approved for use on vitreous enamel
- Always try chemicals you haven't used before on a small discreet area of your cooker
- Do not use paint solvents, washing soda, biological powders, bleach, chlorine-based bleach cleaners, coarse abrasives or salt.
- Do not use steel wool (wire wool), oven cleaning pads or any other materials as these could result in scratches the cookers surface.
- All parts of the cooker can be cleaned with hot soapy water – but take care that no surplus water seeps into the appliance.

| Part | Finish | Recommended Cleaning Method |
|---------------------------------------|---------------------------|---|
| Hotplate | Enamel or stainless steel | <ul style="list-style-type: none"> • Use hot soapy water, soft cloth. • Any stubborn stains remove gently with a nylon scourer/brush. • Cream cleaner can be used for very stubborn stains on enamel and and stainless-steel cleaner can be used for very stubborn stain on stainless steel. |
| Burner caps | Enamel or stainless steel | <ul style="list-style-type: none"> • Use hot soapy water, soft cloth. • Any stubborn stains remove gently with a nylon scourer/brush. • Dishwasher safe. |
| Burner Head | Stainless steel Brass | <ul style="list-style-type: none"> • Use hot soapy water, soft cloth. • Any stubborn stains remove gently with a nylon scourer/brush. • For really stubborn particles or blockages clean with a toothbrush. |
| Ceramic multi-zone (110 models only) | Toughened glass | <ul style="list-style-type: none"> • Use hot water and e-cloth, cream cleaner and scourer if necessary, hob cleaning scraper. • Always ensure any cleaning creams are fully cleaned off with a damp soft cloth and dry with paper towel. |
| Griddle/multi-zone (some models only) | Non-stick Surface | <ul style="list-style-type: none"> • Allow to cool. • Lift off the cooker and wash in hot soapy water, with a soft cloth. • For more stubborn stains use a nylon scourer/brush. Do not use abrasive cleaners or scourers. • Dishwasher safe. |
| Pan Supports Wok Cradle | Cast iron | <ul style="list-style-type: none"> • Allow to cool. Wash in hot soapy water. • Apply cream cleaner or scourer if necessary. • Dishwasher safe. |

| Part | Finish | Recommended Cleaning Method |
|----------------------------|---------------------------|--|
| Hob top surround | Enamel or stainless steel | <ul style="list-style-type: none"> • Hot soapy water; cream cleaner or scourer if necessary. |
| Ceramic or induction hob | Toughened glass | <ul style="list-style-type: none"> • Hot soapy water; cream cleaner or scourer if necessary, hob cleaning scraper. |
| Griddle (some models only) | Non-stick Surface | <ul style="list-style-type: none"> • Allow to cool. • Wash in hot soapy water. Do not use abrasive cleaners/scourers. • Can not be placed in dishwasher due to rubber feet. |

| Part | Finish | Recommended Cleaning Method |
|---|--|---|
| Door, door surround and storage drawer exterior | Enamel or paint | <ul style="list-style-type: none"> Use hot soapy water, soft cloth. Any stubborn stains, remove gently with a liquid detergent. E-cloth or microfiber all-purpose cloth. |
| | Stainless steel | <ul style="list-style-type: none"> E-cloth or microfiber all purpose cloth. Stainless steel cleaner if needed. |
| Sides and plinth | Painted surface | Hot soapy water, soft cloth. |
| Splashback or rear grille | Enamel or stainless steel | Hot soapy water, soft cloth. Cream cleaner if enamel necessary. |
| | | Stainless steel cleaner (if Stainless Steel necessary). |
| Control panel | Paint, enamel or stainless steel | Warm soapy water. Do not use abrasive cleaners/ caustic cleaner on lettering. |
| Control dials, handles and trims | Plastic, chrome, copper or lacquered brass | Warm soapy water, soft cloth. |
| | Brass | Brass polish |
| Oven door glass or glass lid (some models only) | Toughened glass | Hot soapy water, cream cleaner/scourer if necessary. |

| Part | Finish | Recommended Cleaning Method |
|--|---|--|
| Sides, floor and roof of oven Not Cook and Clean Oven panels (see below) | Enamel | <ul style="list-style-type: none"> Do not allow contact with the oven elements. Any proprietary oven cleaner that is suitable for enamel. |
| | | ⚠ CAUTION: CORROSIVE/CAUSTIC OVEN CLEANERS: FOLLOW MANUFACTURER'S INSTRUCTIONS. |
| Cook and Clean oven panels | Special enamel, that partly cleans itself | <ul style="list-style-type: none"> This surface cleans itself at 200 °C and above 392 °F and above. Panels can be removed and washed with hot soapy water and a nylon brush. |
| Oven shelves, Handyrack, Handygrill rack (some models only) | Chrome | <ul style="list-style-type: none"> An oven interior cleaner that is suitable for chrome. Soap filled pad. Dishwasher safe. |
| Grill pan/meat tin (some models only) | Enamel | <ul style="list-style-type: none"> Hot soapy water. Soap filled pad. Dishwasher safe. |
| Telescopic runners | Stainless steel | <ul style="list-style-type: none"> Hot soapy water. Do not put in the dishwasher. |

| Part | Finish | Recommended Cleaning Method |
|-------------------------------|-------------------|---|
| Grill pan | Enamel | <ul style="list-style-type: none"> • Hot soapy water. • Can be left to soak if stubborn stains, nylon scourer/brush. • Dishwasher safe. |
| Grill trivet | Chrome | <ul style="list-style-type: none"> • Hot soapy water. • Can be left to soak if stubborn stains, nylon scourer/brush. • Dishwasher safe. |
| Grill pan runners | | <ul style="list-style-type: none"> • Do not put in dishwasher. • Do not allow contact with the oven elements. |
| Sides, floor and roof of oven | Non-stick Surface | <ul style="list-style-type: none"> • Any proprietary oven cleaner that is suitable for enamel. <p>⚠ CAUTION: CORROSIVE/CAUSTIC OVEN CLEANERS: FOLLOW MANUFACTURER'S INSTRUCTIONS.</p> |

Cleaning Tips and Maintenance

Dual Fuel Hob

| Topic | Tips and Reminders |
|---|---|
| Spills and boil-overs that occur while cooking. | <p>⚠ IMPORTANT: Use an oven glove to protect your hand from potential burns.</p> <ul style="list-style-type: none"> • Turn off the unit and wipe the area surrounding the hot zone with a clean paper towel; • Wipe the enamel top surface of the cooker around the hot plate burners as soon as possible after spills occur. Try to wipe them off while the enamel is still warm. |
| Cookware use | <ul style="list-style-type: none"> • The use of aluminium pans may cause metallic marking of the pan supports. This does not affect the durability of the enamel and may be cleaned off with a suitable metal cleaner. |

Induction Hob

| Topic | Tips and Reminders |
|---|--|
| Accidentally melt anything on the surface or spill foods with a high sugar content. | <ul style="list-style-type: none"> • Remove the spill immediately with a razor scraper, while the unit is still hot. • Scrape the major spill or melted material from the cooking zone and push into a cold area. Then, turn the unit OFF and allow to cool before cleaning further. |
| Prevent scratches and deposits onto the hob panel | <ul style="list-style-type: none"> • Make sure that the base of the pan is clean and dry to prevent any residue burning onto the hob panel. • Make sure that the heat indicator lights are off and that the hob is cool. |
| Remove excess burned on substance | <ul style="list-style-type: none"> • Remove with a single-edged razor scraper. Hold the scraper at an angle of about 30° to the surface and then scrape off the burned-on matter. • Follow the Daily Care procedure after the burned-on matter is removed. |
| Daily care procedures | <p>Make sure that the heat indicator light is off and that the cooking surface is cool.</p> <p>Apply a small dab of ceramic cleaning cream in the centre of the area to be cleaned. Dampen a clean paper towel and work the cream onto the cooking surface. As a final step, wipe the cooking surface with a clean, dry paper towel.</p> |

Removing the Oven Door Interior Glass to Clean

* **Two person lift suggested.**

The oven door interior glasses can be taken off so that they can be cleaned (**Fig. 8.1**).

1. Open the oven door, and carefully lift off the interior oven door glass.
- * **Make sure to lift the glass above the oven door holders.**
2. Slightly tilt the bottom of the glass outward and slowly slide downward.
3. Gently remove the glass away from the oven door.
4. Carefully lift off the middle layer oven door glass. Make sure to lift above the holders.
5. Slightly tilt the bottom of the glass outward, and slowly slide downward. Make sure both rubber clamps come out along with the glass.
6. Remove the rubber clamps.

Re-assembling

The Oven Door Glass

* **Two person lift suggested.**

Refit in the reverse order (**Fig. 8.2**).

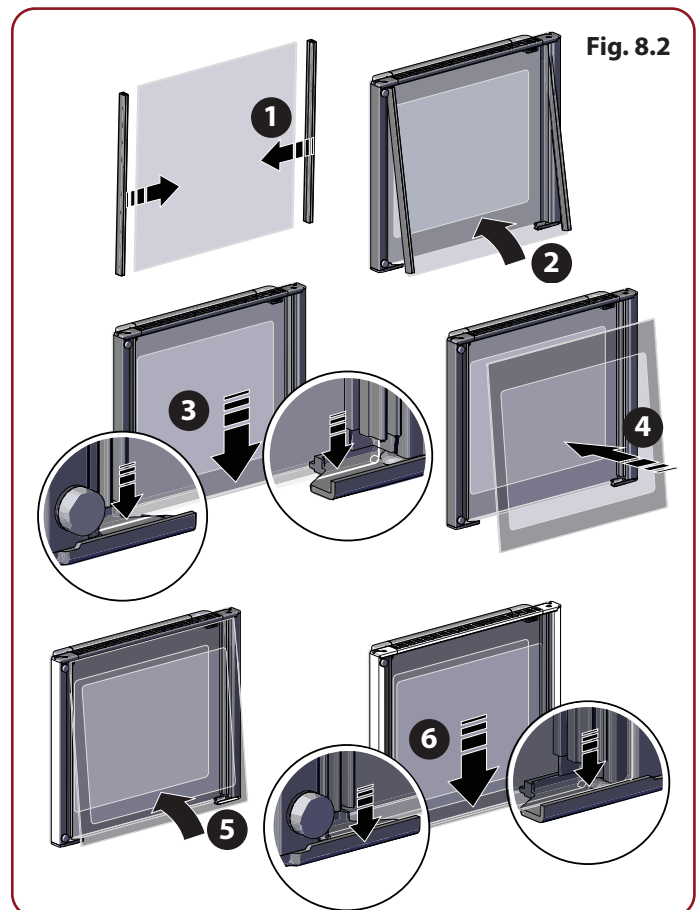
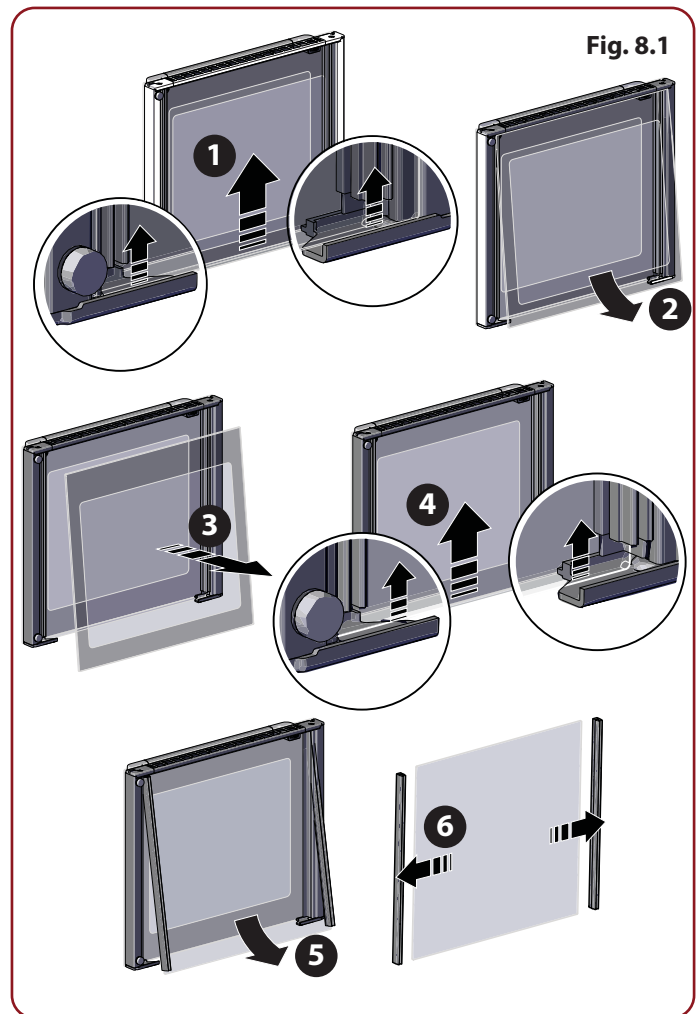
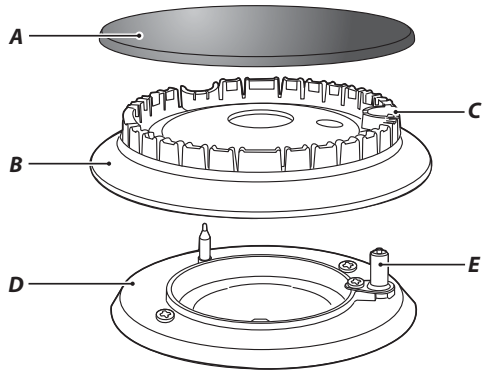

Fig. 8.3



A – Cap, B – Head, C – Notch, D – Base, E – Electrode

The Single Ring Burners

- When refitting the burner head, make sure that the notch lines up with the electrode or hole in the base. Check that the burner head is level and that the cap is fitted centrally on the burner head (**Fig. 8.3**).

Wok Burner

The wok burner can also be taken apart for cleaning.

When reassembling the wok burner, turn over the large base ring and find the 'D' shaped area (**Fig. 8.4**). Turn the head until the 'D' matches the one on the burner base. Flip the burner over once again and place it on the burner base.

Check the burner slots are not blocked. If a blockage occurs, remove stubborn particles using a toothbrush.

Now fit the two burner caps, making sure that they are seated properly.

Check the burner ports are not blocked. If a blockage occurs, remove stubborn particles using a piece of fuse wire.

Fig. 8.4

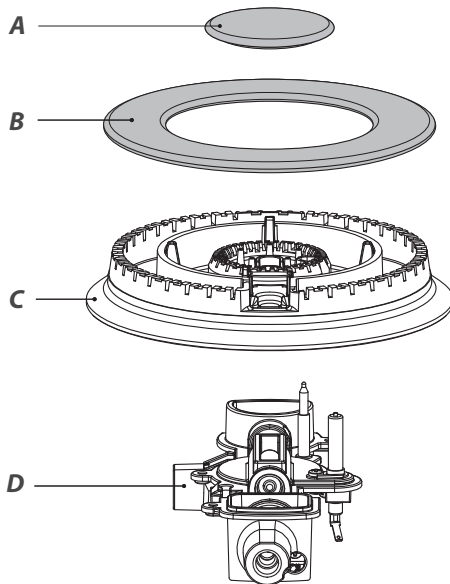

A – inner burner cap, B – outer burner cap,
C – burner head, D – wok burner base

9. Help and Support

⚠ Interference with and repairs to the cooker MUST NOT be carried out by unqualified persons. DO NOT try to repair the cooker as this may result in injury and damage. Contact our Consumer Services to arrange for repairs.

Ceramic Hob

| Issue | Suggestions |
|--|--|
| A crack has appeared in the hob surface. | Disconnect the cooker immediately from the power supply and arrange for its repair. DO NOT use the cooker until after the repair. |
| My hob is scratched | Always use the cleaning methods recommended in this guide, and ensure that the pan bottoms are smooth and clean. Marks from mineral deposits from water or food can be removed with a cleaning cream. However, tiny scratches are not removable but will become less visible in time as a result of cleaning. |
| The timed oven is not coming on when turned on manually | Is the power on? Is the clock illuminated? If not, there may be something wrong with the power supply. Is the cooker supply on at the isolator switch? Has the time of day been set? |
| The timed oven is not coming on when automatic cooking | Has the oven dial been left in the OFF position by mistake? |

Dual Fuel

| Issue | Suggestions |
|---|--|
| Hotplate/Cooktop ignition or hotplate burners faulty | Is the power on? Is the clock illuminated? If not, there maybe something wrong with the power supply. Are the sparker (ignition electrode) or burner slots blocked by debris? Are the burner trim and caps correctly located? See the section on 'Cleaning'. |
| Hotplate/Cooktop burners will not light | Make sure that the burner parts have been replaced correctly after wiping or removing for cleaning. Check that there is not a problem with your gas supply. You can do this by making sure that other gas appliances you may have are working.. |
| Do the burners spark when you push the button? | If not, verify that the power is on by checking that the clock is illuminated |
| Steam is coming from the oven | When cooking foods with high water content (e.g. oven fries) there may be some steam visible at the rear grille. Take care when opening the oven door, as there may be a momentary puff of steam when the oven door is opened. Stand well back and allow any steam to disperse. |
| What cleaning materials are recommended for the cooker? | See the 'Cleaning' section for recommended cleaning materials. Never use caustic or abrasive cleaners as these will damage the surface. |
| If there is an installation problem and I don't get my original installer to come back to fix it who pays? | You do. Service organisations will charge for their call outs if they are correcting work carried out by your original installer. It is in your interest to track down your original installer. |

Induction Hob

Note: The induction hob is able to self-diagnose a number of problems and can show this information to the user via the hob control display. Error codes may be displayed if your hob has developed a fault.

If your appliance reports an error or is not working, you may be able to correct the fault by consulting the following.

| Issue | Suggestions |
|---|---|
| Error code E2 is displayed | The electronic unit is too hot. Please check the installation of the cooker, making sure that there is sufficient ventilation. In extreme cases, if a cooking utensil has been allowed to boil dry this error code may also be displayed. If in doubt please contact your installer or a qualified repair engineer. |
| Error code E3 is displayed | Unsuitable cookware; perform the pan performance check or try alternative cookware with excellent induction. |
| No display operation | Over voltage or loss of supply voltage to the cooker. If in doubt please contact your installer or a qualified repair engineer. |
| Error codes starting with Er-E or if E2 and E3 persist | Manual power reset. If issue persists, consult your installer or a qualified repair engineer. |
| Error code Er followed by a number is displayed | The appliance has developed an internal technical fault that cannot be rectified by the user. Consult your installer or a qualified repair engineer. |
| The fuse blows or the RCD trips regularly | Please contact your installer or a qualified repair engineer. |
| The cooker will not switch on | Has the wiring system in the house blown a fuse or tripped an RCD? Has the cooker been correctly connected to the mains supply? |
| The induction hob is noisy | When using the induction hob there may be some 'noise' emitted from the pan. This is normal and may be most noticeable when cooking on high power settings or if 5 pans are used simultaneously. The type of pan may also contribute to induction 'noise'. |
| The cooling fan | The induction hob incorporates a cooling fan. This cooling fan is active when either the grill or the oven(s) are on. Under certain conditions, the cooling fan may remain active when the grill or oven(s) are switched off. This is normal and the fan will switch off automatically. |
| The fascia gets hot when I use the oven | If the fascia becomes excessively hot when the cooker is in use then the cooling fan may have failed. Should this occur please contact your installer, a qualified repair engineer or Customer Service to arrange for its repair. |
| A crack has appeared in the hob surface | Disconnect the cooker immediately from the power supply and arrange for its repair. Do not use the cooker until after the repair. |

Oven and Grill

| Issue | Suggestions |
|--|--|
| Oven light is not working | <p>The bulb has probably burnt out. You can buy a replacement bulb (which is not covered under the warranty) from a good electrical shop. Ask for a 40W – 230V halogen lamp (G9).</p> <p>Turn off the power at the circuit breaker.</p> <p>Before removing the existing bulb, turn off the power supply and make sure that the oven is cool. Open the oven door and remove the oven shelves.</p> <p>Pull the existing bulb to remove it. When handling the replacement bulb, avoid touching the glass with your fingers, as oils from your hands can cause premature failure. Push, click in the replacement bulb.</p> |
| The fascia gets hot when I use the oven or grill | <p>The cooker is cooled by a fan. If the fascia becomes excessively hot when the cooker is in use then the cooling fan may have failed. Should this occur please contact your installer, a qualified repair engineer or Customer Service to arrange for its repair.</p> |
| The dials get hot when I use the oven or the grill. Can I avoid this? | <p>Yes, this is caused by heat rising from the oven and heating them up. DO NOT leave the oven door open.</p> <p>Make sure that the grill pan is pushed right back to the 'back stop' when grilling.</p> <p>Always grill with the grill compartment door open.</p> |
| Grill is not cooking properly | <p>Are you using the pan and trivet supplied with the cooker?</p> <p>Is the pan being used on the runners, not the floor of the grill compartment?</p> <p>Is the grill tray pushed back fully to the stop?</p> |

Other General

| Issue | Suggestions |
|---|--|
| The oven fan is noisy | <p>The note of the oven fan may change as the oven heats up – this is perfectly normal.</p> |
| The oven is not cooking evenly | <p>DO NOT use a baking tray with dimensions larger than those specified in the section on 'General Oven Tips'.</p> <p>If you are cooking a large item, be prepared to turn it round during cooking.</p> <p>If two shelves are used, check that space has been left for the heat to circulate. When a baking tray is put into the oven, make sure that it is placed centrally on the shelf.</p> <p>Check that the door seal is not damaged and that the door catch is adjusted so that the door is held firmly against the seal.</p> <p>A dish of water when placed on the shelf should be the same depth all over. (For example, if it is deeper at the back, then the back of the cooker should be raised up or the front lowered.) If the cooker is not level, arrange for your supplier to level it for you.</p> |
| Oven not coming on | <p>Is the power on? Is the clock illuminated? If not, there may be something wrong with the power supply.</p> <p>Is the cooker supply on at the isolator switch?</p> <p>Has the time of day been set?</p> |
| Oven temperature getting hotter as the cooker gets older | <p>If turning the temperature down using the oven control dial has not worked, or has only worked for a short time, then you may need a new thermostat. This should be fitted by a qualified service person.</p> |

| Issue | Suggestions |
|--|--|
| My hob is scratched | <p>Always use the cleaning methods recommended in this guide, and make sure that the pan bottoms are smooth and clean.</p> <p>Marks from mineral deposits from water or food can be removed with a cleaning cream. However, tiny scratches are not removable but will become less visible in time as a result of cleaning.</p> |
| Grill not cooking properly | <p>Are you using the pan and trivet supplied with the cooker? Is the pan being used on the runners, not the floor of the compartment? Is the grill tray pushed back fully to the 'back stop' position?</p> |
| The dials get hot when I use the oven or grill. Can I avoid this? | <p>Yes, this is caused by heat rising from the oven or the grill, and heating them up. Do not leave the oven door open. Make sure that the grill pan is pushed right back to the 'back stop' when grilling.</p> <p>Grill door always open during operation</p> <p>Oven doors are always closed during operation.</p> |
| Food is cooking too slowly, too quickly, or burning. | <p>Cooking times may differ from your previous oven. Check that you are using the recommended temperatures and shelf positions – see the oven cooking guide. Then adjust the settings according to your own individual tastes.</p> |
| Power failure | <p>In the event of a failure in the electrical supply, remember to reset the clock to ensure that the timed oven continues to operate.</p> |

10. Installation - Dual Fuel

Safety Requirements and Regulations

- ⚠ **This cooker must be installed in accordance with the relevant instructions in this booklet, with the relevant national and local regulations, and with the local gas and electricity supply companies' requirements.**
- ⚠ **This cooker is a Class 2 Subclass 1 appliance.**
- ⚠ **Before installation, make sure that the cooker is suitable for your gas type and supply voltage. See the data badge.**
- ⚠ **The appliance must be installed in accordance with the regulations in force and only in a well ventilated space.**
- ⚠ **Read the instructions before installing or using this appliance.**
- ⚠ **In your own interest and that of safety, it is law that all gas appliances be installed by competent persons. Failure to install the appliance correctly could invalidate any warranty or liability claims and lead to prosecution.**
- ⚠ **This appliance can be converted for use on another gas.**

Provision of Ventilation

This appliance is not connected to a combustion products evacuation device. Particular attention shall be given to the relevant requirements regarding ventilation.

All rooms require a window that can be opened, or equivalent, while some rooms require a permanent vent in addition to the window.

Location of Cooker

The cooker may be installed in a kitchen/kitchen diner but NOT in a room containing a bath or shower.

This appliance is designed for domestic cooking only. Use for any other purpose could invalidate any warranty or liability claim.

Note: An appliance for use on LPG must not be installed in a room or internal space below ground level, e.g. in a basement.

Conversion

This appliance is supplied set for G20 20 mbar Cat II_{2H3+}.

A conversion kit for another gas is available for the cooker.

If the appliance is to be converted to another gas we recommend that this is carried out before installation.

- ⚠ **We recommend an overpressure shut-off device or pressure relief valve be used in any LPG installation to prevent exposure of downstream fittings / appliances to excessive pressure (over 75mbar) in event of regulator failure.**

After converting the appliance, please attach the Gas Conversion sticker over the appropriate area of the data badge – this will identify the gas type for which the appliance is now set.

You will need the following equipment to complete the cooker installation satisfactorily:

- Stability bracket: If the cooker is to be supplied with gas through a flexible hose, a stability bracket or chain must be fitted. **These are not supplied with the cooker but are available at most builders' merchants.**
- Gas pressure tester/manometer.
- Flexible gas hose: Must be in accordance with the relevant standards.
- Multimeter: For electrical checks.

INSTALLATION

Check the appliance is electrically safe and gas sound when you have finished.

Checking the parts:

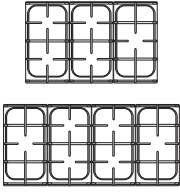
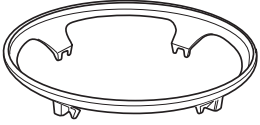
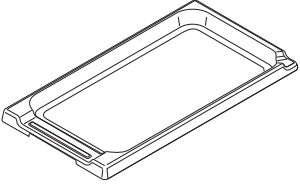
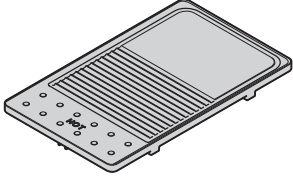
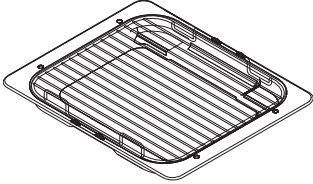
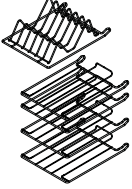
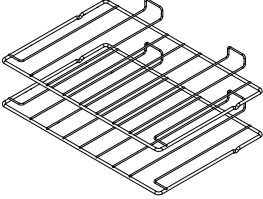
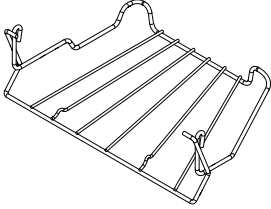
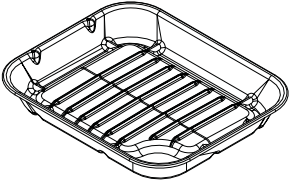
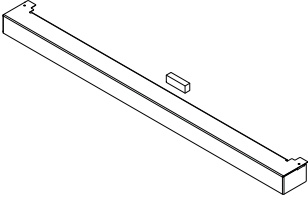
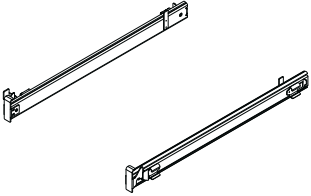
| | |
|---|---|
| 3 / 4 Pan Supports (depending on size) | Wok Cradle (model dependant) |
|  |  |
| Deluxe Griddle (model dependant) | Classic Griddle (model dependant) |
|  |  |
| Grill Pan and Trivet | Tall Oven Shelves & Plate Rack (model dependant) |
|  |  |
| Flat Shelves (main oven) | Handyrack (model dependant) |
|  |  |
| Roasting Tin | Plinth |
|  |  |
| Telescopic Runners (model dependant) | |
|  | |

You will also need the following tools:

1. Electric drill
2. Masonry drill bit (only required if fitting the cooker on a stone or concrete floor)
3. Wall plugs (only required if fitting the cooker on a stone or concrete floor)
4. Steel tape measure
5. Cross head screwdriver
6. Flat head screwdriver
7. Spirit level
8. Pencil
9. Adjustable spanner
10. 13 mm spanner or socket wrench

INSTALLATION

Check the appliance is electrically safe and gas sound when you have finished.

Positioning the Cooker

Fig. 10.1 and **Fig. 10.2** shows the minimum recommended distance from the cooker to nearby surfaces.

The cooker should not be placed on a base.

Fig. 10.1 and **Fig. 10.2** Cookers installed into recess: The cooker must have side clearance **ABOVE** hob level of 75mm up to a height of 410mm. This can be reduced to 25mm if the surface is made from a non-combustible material.

A minimum space of 650 mm is required between the top of the hob and a horizontal combustible surface.

*Any cookerhood should be installed in accordance with the hood manufacturer's instructions.

**Any splashback must be fitted in accordance with the manufacturers instructions. Allowance should be made for the additional height of the flue trim, which is fitted to the cooker hob.

Surfaces of furniture and walls at the sides and rear of the appliance should be heat, splash and steam resistant. Certain types of vinyl or laminate kitchen furniture are particularly prone to heat damage and discolouration. We cannot accept responsibility for damage caused by normal use of the cooker to any material that de-laminates or discolours at temperatures less than 65 °C above room temperature.

DO NOT box the cooker in – it must be possible to move the cooker in and out for cleaning and servicing.

To allow the oven doors to open, a clearance of 130 mm is required if the cooker is near a corner of the kitchen (**Fig. 10.3**). The actual opening of the doors is slightly less, but this allows for some protection of your hand as you open the door.

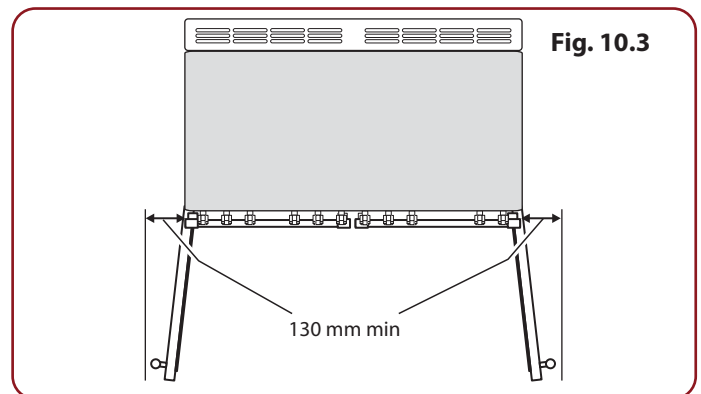
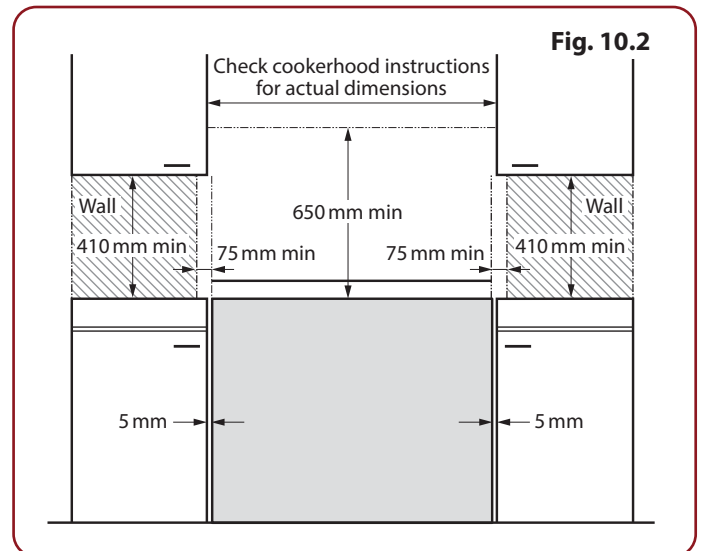
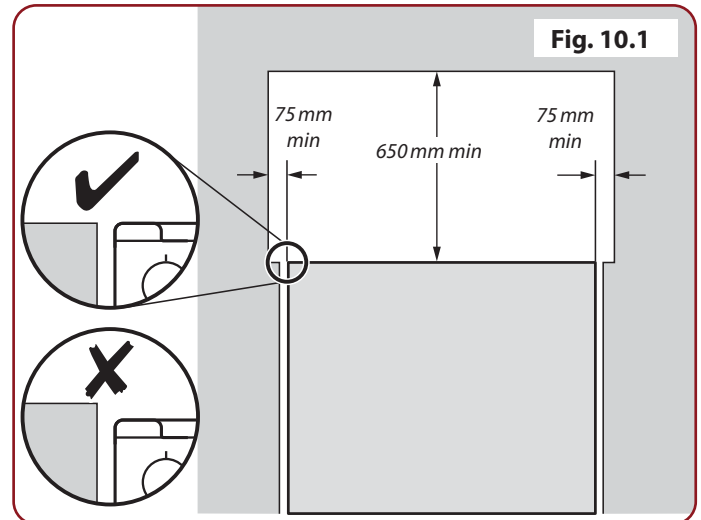

INSTALLATION

Check the appliance is electrically safe and gas sound when you have finished.

Fig. 10.4

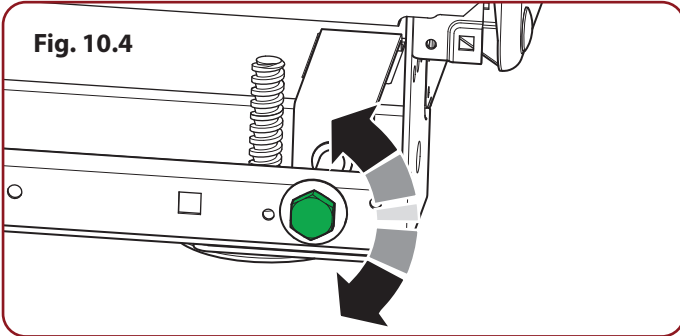

Adjusting the Two Rear Rollers

To adjust the height of the rear of the cooker, first fit a 13 mm spanner or socket wrench onto the hexagonal adjusting nut (**Fig. 10.4**). Rotate the nut – clockwise to raise – counter-clockwise to lower.

Make 10 complete (360°) turns clockwise.

Make sure you lower BOTH REAR ROLLERS.

Adjusting the Front Feet

To adjust the height of the front of the cooker, turn the screw-down feet – clockwise to raise – anti-clockwise to lower.

Fitting the Stability Chain

Unless otherwise stated, a cooker using a flexible gas connector must be secured with a suitable stability device.

If you are using a stability chain (**Fig. 10.5**) then the chain should be kept as short as is practicable and fixed firmly to the rear of the cooker.

Fig. 10.5

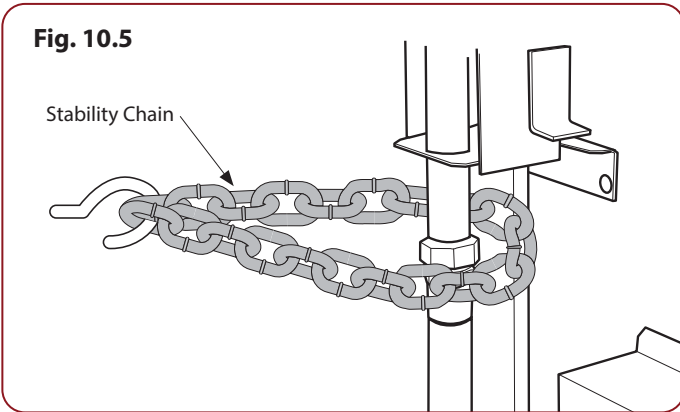

INSTALLATION

Check the appliance is electrically safe and gas sound when you have finished.

Gas Connection

This must be in accordance with the relevant standards.

The flexible hose (not supplied with the cooker) must be in accordance with the relevant standards. Hoses may be purchased at most builders' merchants.

The connector is located just below the hotplate level at the rear of the cooker. If in doubt contact your supplier.

The rear cover boxes limit the position of the supply point.

Because the height of the cooker can be adjusted and each connection is different, it is difficult to give precise dimensions.

Although a 900 mm hose can be used, a 1250 mm hose will allow slightly more flexibility in the positioning of the bayonet and make moving the cooker easier.

The hose should be fitted so that both inlet and outlet connections are vertical so that the hose hangs downwards in a 'U' shape.

Ideally the hose supply connection should be within the shaded area 'A' (**Fig. 10.6**).

Screw connect the threaded end of the hose into the gas inlet.

After completing the gas connection, make sure that the cooker is gas sound with a pressure test.

Pressure Testing

The gas pressure can be measured at one of the hotplate burner injectors (not a wok burner).

Lift off a burner head. Fit the pressure gauge to the injector. Turn on and light one of the other hotplate burners.

Turn on the control dial for the burner with the pressure gauge fitted to let gas through.

See the data badge for test pressures.

Turn off the burners. Make sure that you reassemble the burner top in the correct way on the burner body.

Fig. 10.6

Gas inlet

A

675

315

470

350

All dimensions in millimetres

48

INSTALLATION

Check the appliance is electrically safe and gas sound when you have finished.

Current Operated Earth Leakage Breakers

The combined use of your induction cooker and other domestic appliances may cause nuisance tripping, so we recommend that the cooker is protected on an individual RCD (Residual Current Device) or RCBO (Residual Current Breaker with Overload).

IF IN DOUBT, PLEASE CONSULT A SUITABLY QUALIFIED ELECTRICIAN.

Fig. 10.7

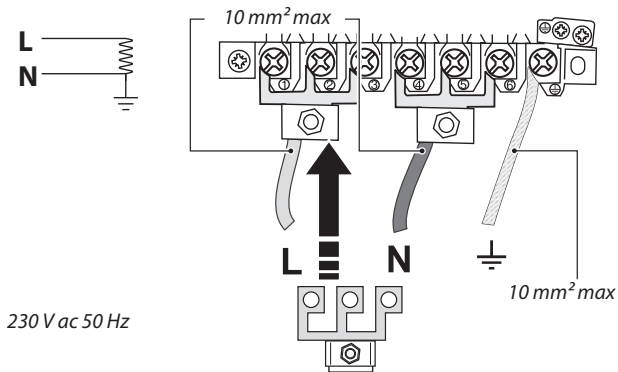
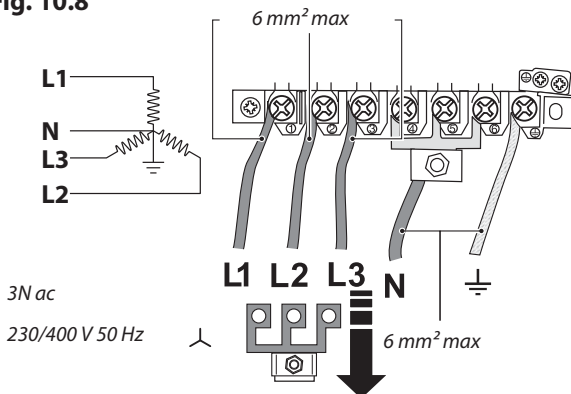

Fig. 10.8



Electrical Connection

The cooker must be installed by a qualified electrician, in accordance with all relevant national and local regulations.

⚠ WARNING: THE APPLIANCE MUST BE EARTHED.

Note: The cooker must be connected to a dedicated 32-amp supply, through a suitable cooker control unit incorporating a double-pole switch having a contact separation at least 3 mm in all poles. The switch must be in the same room, within 2 metres of the cooker and accessible.

⚠ The cooker MUST NOT be connected to an ordinary domestic power point.

Access to the mains terminal is gained by removing the electrical terminal cover box on the back panel. Connect the mains cable to the correct terminals for your electrical supply type (**Fig. 10.7** and **Fig. 10.8**). It should be made with 6.0mm twin and earth cable. Check that the links are correctly fitted and that the terminal screws are tight. Secure the mains cable using the cable clamp.

INSTALLATION

Check the appliance is electrically safe when you have finished.

11. Installation - Induction

Safety Requirements and Regulations

- ⚠** This cooker must be installed in accordance with the relevant instructions in this booklet, with the relevant national and local regulations, and with the local electricity supply companies' requirements.
- ⚠** The appliance must be installed in accordance with the regulations in force and only in a well ventilated space.
- ⚠** Read the instructions before installing or using this appliance.

Provision of Ventilation

This appliance is not connected to a combustion products evacuation device. Therefore, particular attention must be given to the relevant requirements regarding ventilation.

All rooms require a window that can be opened, or equivalent, while some rooms require a permanent vent in addition to the window.

Location of Cooker

The cooker may be installed in a kitchen/kitchen diner but NOT in a room containing a bath or shower.

- ⚠** This appliance is designed for domestic cooking only. Use for any other purpose could invalidate any warranty or liability claim.

You will need the following equipment to complete the cooker installation satisfactorily:

- Multimeter (for electrical checks).

You will also need the following tools:

1. Steel tape measure
2. Cross-head screwdriver
3. Flat-bladed screwdriver
4. Spirit level
5. Pencil
6. Adjustable spanner
7. 3 mm and 4 mm Allen keys
8. 13 mm spanner or socket wrench

Checking the parts:

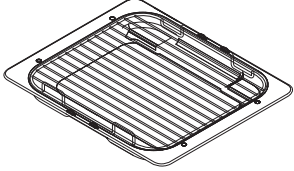
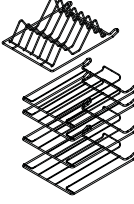
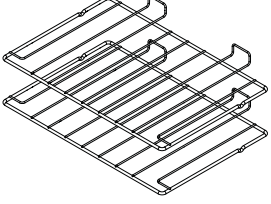
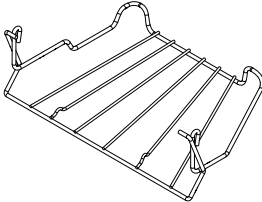
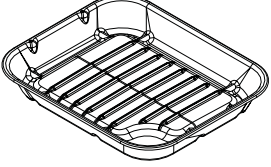
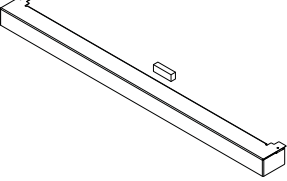
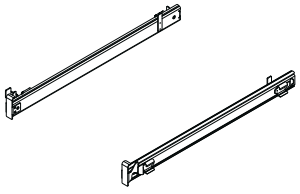
| | |
|--|---|
| Induction Griddle (model dependant) | Grill Pan and Trivet |
|  |  |
| Tall Oven Shelves & Plate Rack (model dependant) | Flat Shelves (main oven) |
|  |  |
| Handyrack (model dependant) | Roasting Tin |
|  |  |
| Plinth | Telescopic Runners (model dependant) |
|  |  |

INSTALLATION

Check the appliance is electrically safe when you have finished.

Positioning the Cooker

Fig. 11.1 and **Fig. 11.2** show the minimum recommended distance from the cooker to nearby surfaces.

The cooker should not be placed on a base.

Fig. 11.1 and **Fig. 11.2** Cookers installed into recess: The cooker must have side clearance **ABOVE** hob level of 75mm up to a height of 410mm. This can be reduced to 25mm if the surface of the side wall is non-combustible.

A minimum space of 650 mm is required between the top of the hob and a horizontal combustible surface.

*Any cookerhood should be installed in accordance with the hood manufacturer's instructions.

**Any splashback must be fitted in accordance with the manufacturers instructions. Allowance should be made for the additional height of the flue trim, which is fitted to the cooker hob.

Surfaces of furniture and walls at the sides and rear of the appliance should be heat, splash and steam resistant. Certain types of vinyl or laminate kitchen furniture are particularly prone to heat damage and discolouration. We cannot accept responsibility for damage caused by normal use of the cooker to any material that de-laminates or discolours at temperatures less than 65°C above room temperature.

DO NOT box the cooker in – it must be possible to move the cooker in and out for cleaning and servicing.

If the cooker is near a corner of the kitchen, a clearance of 130 mm is required to allow the oven doors to open (**Fig. 11.3**). The actual opening of the doors is slightly less, but this allows for some protection of your hand as you open the door.

Fig. 11.1

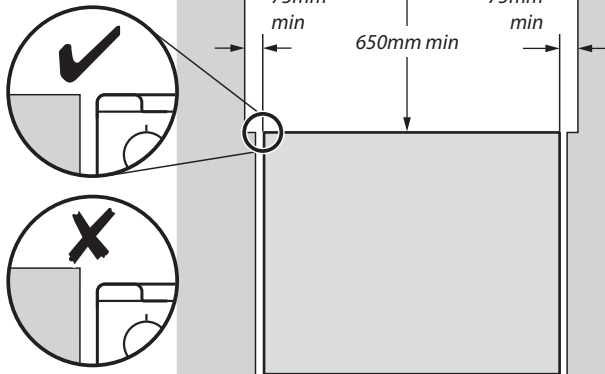

Fig. 11.2

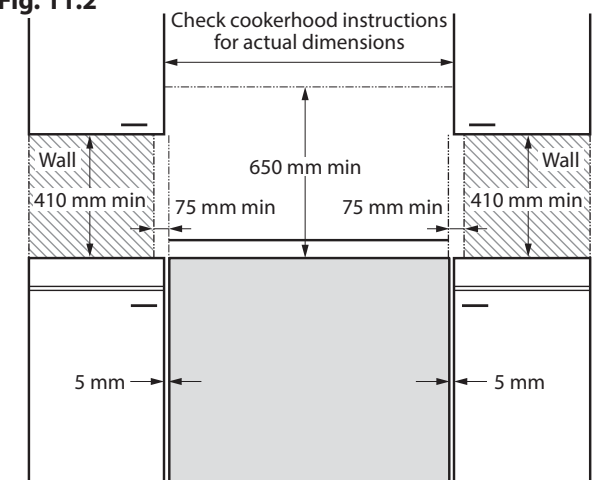
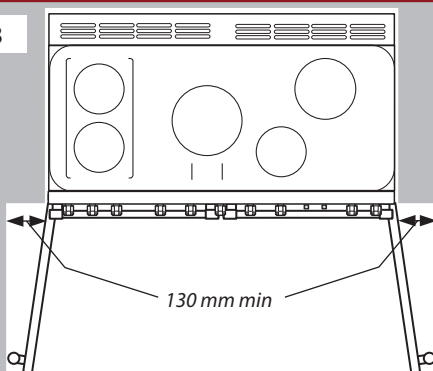

Fig. 11.3



INSTALLATION

Check the appliance is electrically safe when you have finished.

Adjusting the height: Rear

To adjust the height of the rear of the cooker, first fit a 13 mm spanner or socket wrench onto the hexagonal adjusting nut (Fig. 11.4). Rotate the nut – clockwise to raise – counter-clockwise to lower.

Adjusting the height: Front

Fit the supplied spanner onto the integrated hexagonal adjusting nut (Fig. 11.5). Rotate the nut – clockwise to raise – counter-clockwise to lower.

Positioning the Plinth Magnet

Add the magnet to the base front in between the slotted features (Fig. 11.6).

⚠ The plinth magnet must align properly, otherwise, it will block the fitting of the plinth.

Assembling the Plinth

There are 2 parts of the plinth - the *Outer part* and the *Inner part*.

⚠ Before the assembling, make sure both plinths are in the correct orientation (Fig. 11.7).

1. Fit the outer plinth to the inner plinth to form a single unit, as shown.
2. Align both sides of the plinth with the cooker base. Move and insert the plinth slowly until the magnet engaged. Allow the inner plinth to drop down to the floor.

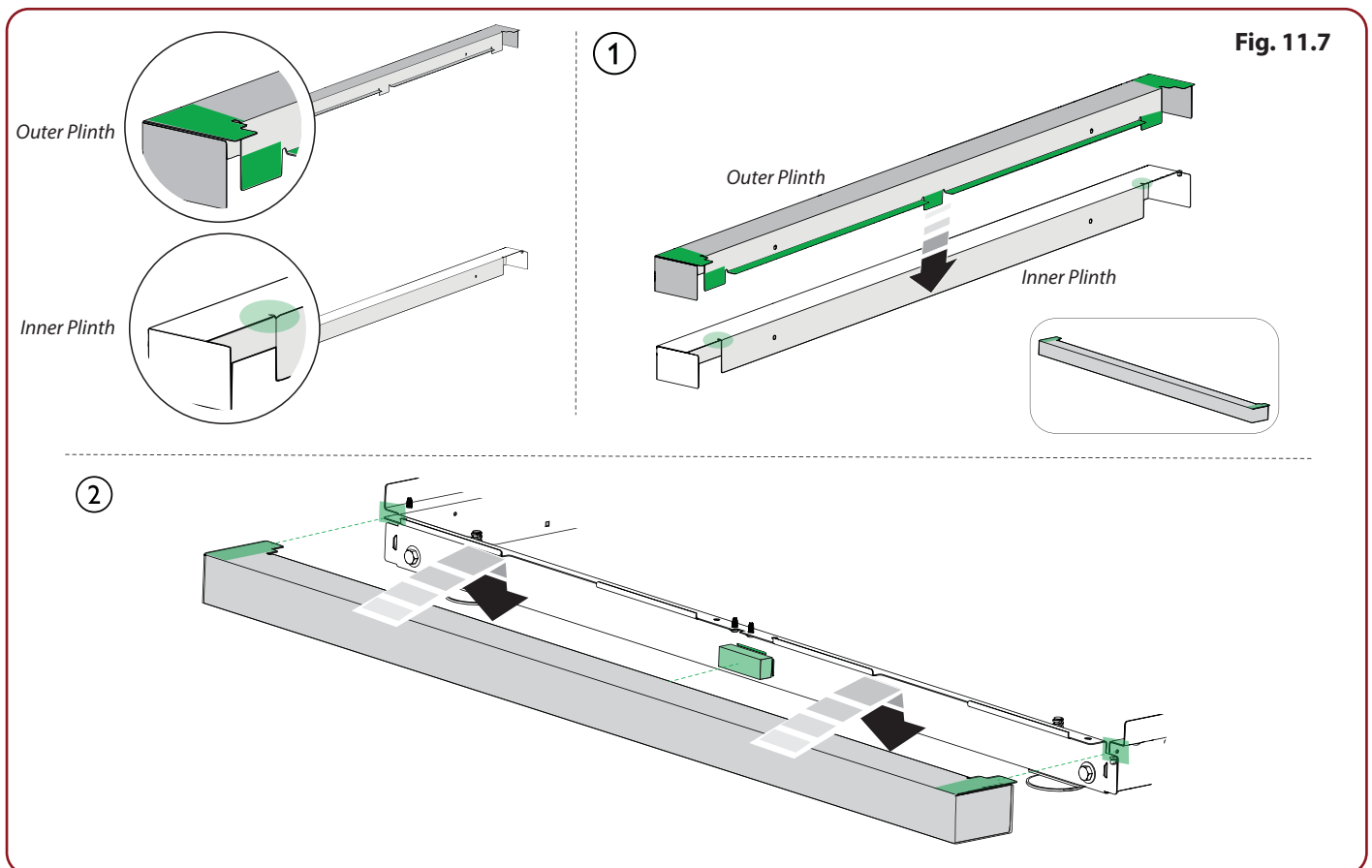
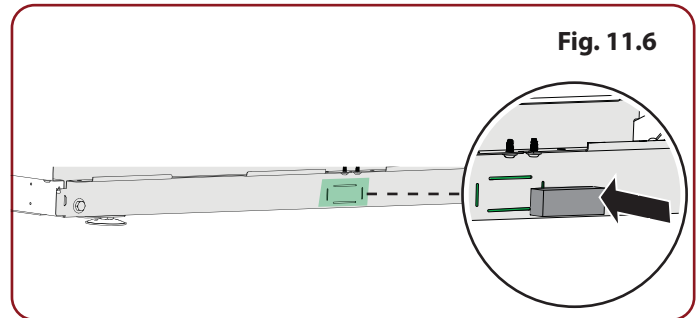
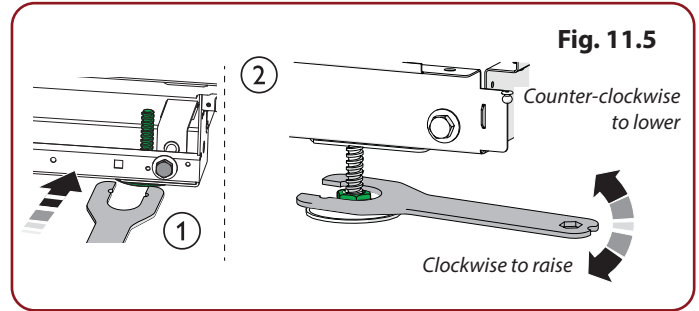
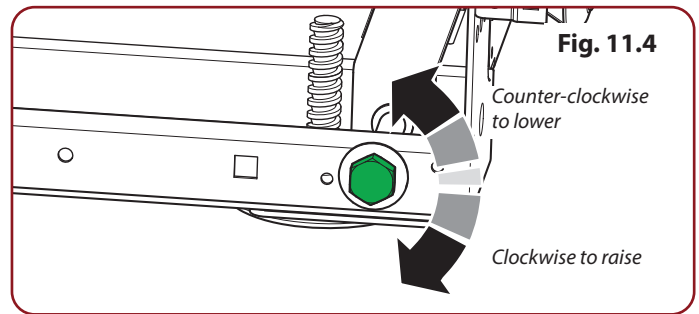

INSTALLATION

Check the appliance is electrically safe when you have finished.

Current Operated Earth Leakage Breakers

The combined use of your induction cooker and other domestic appliances may cause nuisance tripping, so we recommend that the cooker is protected on an individual RCD (Residual Current Device) or RCBO (Residual Current Breaker with Overload).

IF IN DOUBT, PLEASE CONSULT A SUITABLY QUALIFIED ELECTRICIAN.

Fig. 11.8

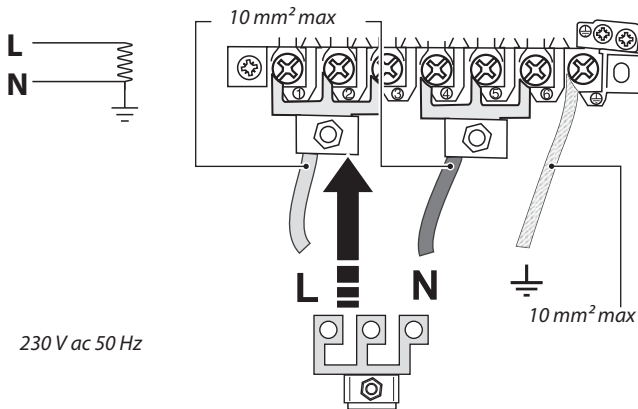

Fig. 11.9

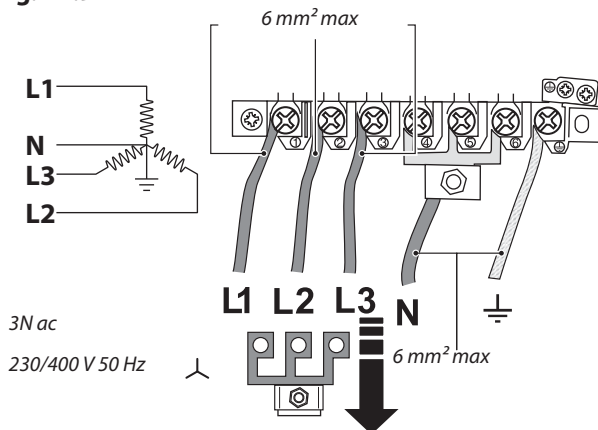

Fig. 11.10

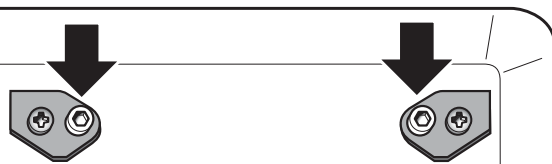

Fig. 11.11



Electrical Connection

The cooker must be installed by a qualified electrician, in accordance with all relevant Standards/Codes of Practice, or with the relevant national and local regulations.

⚠ WARNING: THE APPLIANCE MUST BE EARTHED.

Note: The cooker must be connected to a dedicated minimum *32-amp supply through a suitable cooker control unit incorporating a double-pole switch, having a contact separation of at least 3 mm in all poles. The switch must be in the same room, within 2 metres of the cooker and accessible.

* Providing the cooker control switch does not incorporate a 13-amp socket, as the minimum supply would increase to 40-amp.

⚠ The cooker MUST NOT be connected to an ordinary domestic power point.

Access to the mains terminal is gained by removing the electrical terminal cover box on the back panel. Connect the mains cable to the correct terminals for your electrical supply type (Fig. 11.8 and Fig. 11.9). It should be made with 6.0mm twin earth cable for 32-amp supply and 10.0mm twin and earth cable for 40 to 50-amp supply. Check that the links are correctly fitted and that the terminal screws are tight.

Secure the mains cable using the cable clamp.

Final Checks

Hob Check

Check each cooking zone in turn. Be sure to use pans of the correct size and material.

Grill Check

Turn on the grill control and check that the grill heats up.

Oven Check

Set the clock as described earlier, and then turn on the ovens. Check the oven fans start to turn and that the ovens heat up.

Final Fitting

Fitting the Handles and Handrail (depending on model)

Remove the 4 mm Allen screws from the doors (Fig. 11.10). Fit the door handles and secure using the 4 mm screws.

⚠ The handles should be above the fixings.

Remove the 4 mm Allen screws from the top corners of the fascia (Fig. 11.11). Fit the front handrail in position and secure using the 4 mm screws.

Fitting the Splashback (depending on model)

Position the splashback on the rear of the hotplate and secure with the screws supplied.

Customer Care

Installer: Please complete your details in this guide, inform the user how to operate the cooker and hand over the instructions.

12. Legal Guide

ALL PICTURES SHOWN ARE FOR ILLUSTRATION PURPOSES ONLY. ACTUAL PRODUCTS AND COMPONENTS MAY VARY DUE TO PRODUCT ENHANCEMENT.

Address of the manufacturer:

AGA RANGEMASTER, Clarence Street, Royal Leamington Spa, Warwickshire, CV31 2AD, England

Before You Start ...

- **CAUTION:** A long term cooking process has to be supervised from time to time. A short term cooking process has to be supervised continuously.
- **WARNING:** Danger of fire: **DO NOT** store items on the cooking surfaces.
- If anything is stored above or around the range cooker. Temperatures may be unsafe for flammable or combustible materials / items / liquids.
- **DO NOT** use the cooker cavities for storage, items could become fire hazards when cooker is turned on.
- To avoid overheating, **DO NOT** install the cooker behind a decorative door.
- **NEVER** heat unopened food containers. Pressure build up may make the containers burst and cause injury.
- **DO NOT** use a steam cleaner on your cooker.
- **WARNING:** The appliance and its accessible parts become hot during use and will retain heat even after you have stopped cooking. Care should be taken to avoid touching heating elements.
- This appliance can be used by children aged from years and above and persons with reduced physical, sensory or mental capabilities or lack of experience and knowledge if they have been given supervision or instruction concerning use of the appliance in a safe way and understand the hazards involved. Children shall not play with the appliance. Cleaning and user maintenance shall not be made by children without supervision.
- The hob and grill are attended operations and can cause a hazard.
- The cooker should not be placed on a base.
- **WARNING:** Before replacing the bulb, turn off the power supply to avoid the possibility of electric shock. Make sure that the oven is cool.
- **WARNING:** Unattended cooking on a hob with fat or oil can be dangerous and may result in fire.
- **DO NOT** use water on grease fires and never pick up a flaming pan. Turn the controls off and then smother a flaming pan on a surface unit by covering the pan completely with a Fire blanket or a well-fitting lid.
- **DO NOT** modify this appliance. This appliance is not intended to be operated by means of external timer or separated remote-control system.
- **(Induction/Ceramic appliance):** Take care **NOT** to place metallic objects such as knives, forks, spoons and lids on the hob surface since they can get hot.
- After use, switch off the hob element by its control. **DO NOT** rely on the pan detector.
- **DO NOT** use harsh abrasive cleaners or sharp metal scrapers to clean the oven door glass since they can scratch the surface, which may result in shattering of the glass.

- **IMPORTANT INFORMATION FOR PACEMAKER AND IMPLANTED INSULIN PUMP USERS:** The functions of this hob comply with the applicable European standards on electromagnetic interference. If you are fitted with a pacemaker or implanted insulin pump and are concerned please consult your doctor for medical advice.

Operation / Usage

- **CAUTION:** This appliance is for cooking purposes only. It must not be used for other purposes, for example heating a room. Using it for any other purpose will waste fuel and may overheat the control dials.
- **CAUTION:** Accessible parts may be hot when the grill and/or the oven are in use. young children shall be kept away.
- **CAUTION:** The use of a cooking appliance results in the production of heat and moisture in the room in which it is installed. Therefore, make sure that the kitchen is well ventilated: keep natural ventilation holes open or install a powered cooker hood that vents outside. If you have several hotplates/burners on, or use the cooker for a long time, open a window or turn on an extractor fan. If you don't have an extractor fan consult a professional before installation of the additional ventilation.

Oven Shelves

Any shelf can be fitted in any of the positions. The oven shelves are retained when pulled forward but can be easily removed and refitted.

- **To Remove and Refit the Ladder Shelf Supports.** Lift the ladder support hooks out of the two locating holes in the oven side (or divider) before lifting the support clear of the bottom ladder restraint. Refit by inserting the bottom of the ladder

into the restraint before fitting the hooks through the locating holes.

- **To Remove and Refit the Shelves.** Pull the shelf forwards until the back of the shelf is stopped by the shelf support. Lift up the front of the shelf so the back of the shelf will pass between the supports and then pull the shelf forward. Refit in the reverse order, making sure to push it fully back.
- To fit the glide-out shelf, hook the front of the shelf onto the runners. The rear of the shelf should rest on the runners, in front of the rear stop.

Operating the Oven

The multifunction oven has two controls: a function selector and a temperature setting dial. Turn the function selector control to a cooking function. Turn the oven temperature dial to the temperature you need. The oven heating light will glow until the oven has reached the temperature you selected. It will then cycle on and off during cooking as the oven maintains the selected temperature.

Operating the Grill

- Open the door and pull the grill pan carriage forward using the handle. The grill has two elements that allow either the whole area of the pan to be heated or just the right-hand half.
- Adjust the heat to suit by turning the dial. To heat the whole grill, turn the dial clockwise. To heat the right-hand half, turn the dial counter-clockwise. The neon indicator light by the grill control will come on.
- Slide the carriage back into the grill chamber. The grill trivet can be removed, and the food placed on it while you are waiting for the grill to preheat.
- Once the grill has preheated, slide the carriage out again. With the trivet back in place with the food on it, slide the carriage back into the grill chamber. Make sure that

it is pushed right in otherwise the control dials may become very hot.

- **NEVER** close the grill door when the grill is in use.
- Close the grill door **after** the grill is turned off.

Operating the Hot Plate

- **Gas Appliance.** To light a burner, push in for ignition and turn the control dial to the high position as indicated by the large flame symbol. The igniter should spark and light the gas. Keep holding the dial pressed in to let the gas through to the burner for about ten seconds. If, when you let go of the control dial, the burner goes out, then the FSD has not been bypassed. Turn the control dial to the OFF position and wait for one minute before you try again, this time making sure to hold in the control dial for slightly longer.
- **Gas Appliance. DO NOT** use hotplate protectors, foil or hotplate covers of any description. These may affect the safe use of your hotplate burners and are potentially hazardous to health.
- **Gas Appliance.** Minimum recommended pan diameter is 120 mm.
- Pans and kettles with concave bases or down-turned base rims should not be used.
- **DO NOT** use cooking vessels on the hotplate that overlap its edges.
- You should also avoid using unstable and misshapen pans that may tilt easily, and pans with a very small base diameter, e.g. milk pans, single egg poachers. Make sure that you position the handles away from the edge of the hotplate.

Ceramic Surface Care

- **ALWAYS LIFT** pans off the hob. Sliding pans may cause marks and scratches.
- Take care **NOT TO PLACE HOT LIDS** onto the hob surface. Should this occur, **DO NOT** attempt to lift the lid off, instead slide the lid to the edge.

Oven Care and Cautions

- Ensure cooker is off and cooled down before starting cleaning process.
- When cooking foods be careful of steam bursts when opening the oven door.
- Take care when closing the oven doors as the glass can shatter or fracture.
- Keep rear hotplate vents unobstructed.
- When the oven is on, **DO NOT** leave the oven door open for longer than necessary, otherwise the control dials and handles may become very hot.
- Always keep the cooker clean from food and fats buildup to avoid health, safety and fire hazards. Only use recommended cleaners.
- Take care no liquids enter the appliance.

Installation

Safety Requirements and Regulations

- You must be aware of the following safety requirements & regulations:
- This cooker must be installed in accordance with the regulations in force and the relevant national and local regulations, and with the local electricity and gas supply companies' requirements.
- A registered engineer should service the cooker and only approved spare parts should be used.
- The appliance must be installed only in a well-ventilated space.

- **DO NOT** use the control dials, handles and towel rails to manoeuvre the cooker.
- Read the instructions before installing or using this appliance.
- **(Gas appliance).** Prior to installation, ensure that the local distribution conditions (nature of the gas and gas pressure) and the adjustment of the appliance are compatible.
- **(Gas appliance).** This appliance is not connected to a combustion products evacuation device. It shall be installed and connected in accordance with current installation regulations. Particular attention shall be given to the relevant requirements regarding ventilation.

Electrical Connection

- The cooker must be installed by a qualified electrician, in accordance with all relevant Standards/Codes of Practice, or with the relevant national and local regulations.
- **WARNING: THE APPLIANCE MUST BE EARTHED.**
- **Note:** The cooker must be connected to a dedicated minimum *32-amp supply through a suitable cooker control unit incorporating a double-pole switch, having a contact separation of at least 3 mm in all poles. The switch must be in the same room, within 2 metres of the cooker and accessible.

* Providing the cooker control switch does not incorporate a 13-amp socket, as the minimum supply would increase to 40-amp.

- **The cooker MUST NOT be connected to an ordinary domestic power point.**
- Access to the mains terminal is gained by removing the electrical terminal cover box on the back panel. Connect the mains cable to the correct terminals for your electrical

supply type (**Fig. 12.1 & Fig. 12.2**). Check that the links are correctly fitted and that the terminal screws are tight.

- Secure the mains cable using the cable clamp.

Gas Connection (gas appliance)

- This must be in accordance with the relevant standards. The connector is located just below the hotplate level at the rear of the cooker.
- Only use LPG conversion kits supplied by the manufacturer.
- The rear cover boxes limit the position of the supply point. As the height of the cooker can be adjusted and each connection is different, it is difficult to give precise dimensions.
- Although a 900 mm hose can be used, a 1250 mm hose will allow slightly more flexibility in the positioning of the bayonet and make moving the cooker easier.

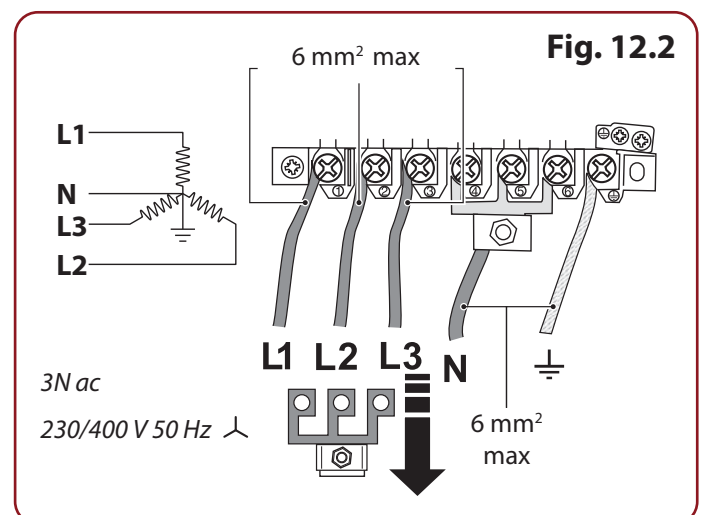
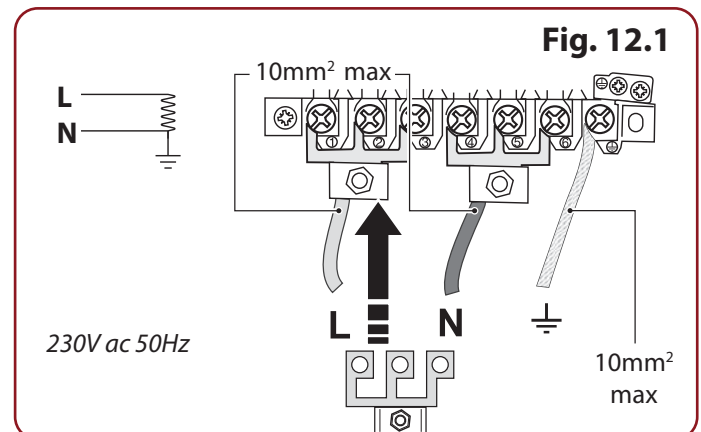

- The hose should be fitted so that both inlet and outlet connections are vertical so that the hose hangs downwards in a 'U' shape. For Natural Gas, the flexible hose must be in accordance with **BS 669**. For LP Gas, it should be capable of 50 mbar pressure, 70°C temperature rise, and carry a red stripe, band or label. If in doubt contact your supplier.
- The flexible tube shall be fitted in such a way that it cannot come into contact with a moveable part of the housing unit (e.g. a drawer) and shall not pass through any space susceptible of becoming congested.
- Screw connect the threaded end of the hose into the gas inlet. After completing the gas connection, make sure that the cooker is gas sound with a pressure test.

Pressure Testing for Correct Operation

- The gas pressure can be measured at one of the hotplate burner injectors (not a wok burner).
- Lift off a burner head. Fit the pressure gauge to the injector. Turn on and light one of the other hotplate burners.
- Turn on the control dial for the burner with the pressure gauge fitted to let gas through.
- See the data badge for test pressures.
- Turn off the burners. Make sure that you reassemble the burner top in the correct way on the burner body.

Lower the Two Rear Rollers

- To adjust the height of the rear of the cooker, first fit the correct spanner or socket wrench onto the hexagonal adjusting nut. Rotate the nut – clockwise to raise – counter clockwise to lower.
- Make 10 complete (360°) turns clockwise. Make sure you lower **BOTH REAR ROLLERS**.

Positioning the Cooker

- The diagram shows the minimum recommended distance from the cooker to nearby surfaces (**Fig. 12.3**).
- **Fig. 12.3** Cookers installed into recess: The cooker must have side clearance **ABOVE** hob level of 75 mm up to a height of 410 mm. This can be reduced to 25 mm if the surface of the side wall is non-combustible.
- A minimum space of 650 mm is required between the top of the hotplate and a horizontal combustible surface.
- **DO NOT** box the cooker in – it must be possible to move the cooker in and out for cleaning and servicing.

Maintenance and Troubleshooting

- This cooker is a Class 2, Subclass 1 appliance.
- Before removing the existing bulb, turn off the power supply and make sure that the oven is cool. Open the oven door and remove the oven shelves.
- **(Induction/Ceramic appliance):**
WARNING: Should a crack appear in the surface, disconnect the appliance immediately from the supply and arrange for its repair to avoid the possibility of electric shock.
- The cooker is cooled by a fan. If the fascia becomes excessively hot when the cooker is in use, then the cooling fan may have failed. Should this occur please contact your installer, a qualified repair engineer or Customer Service to arrange for its repair.
- The appliance and its accessible parts become hot during use and will retain heat even after you have stopped cooking. Care should be taken to avoid touching heating elements inside the oven.

Fig. 12.3

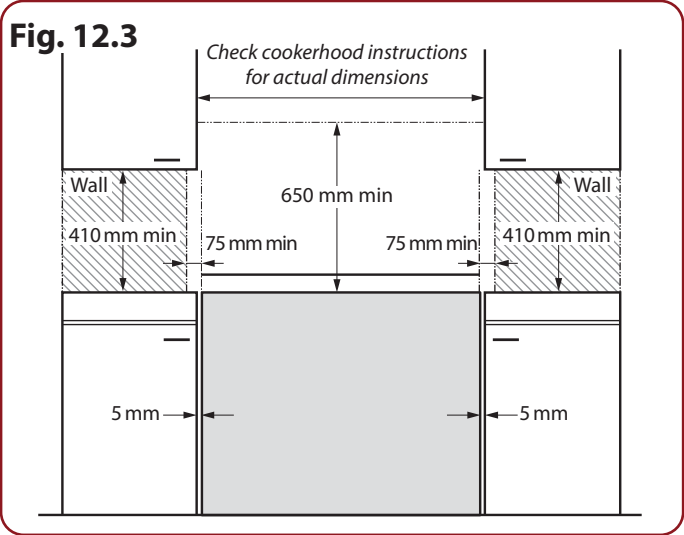

- **WARNING:** Use only hob guards designed by the manufacturer of the cooking appliance or indicated by the manufacturer of the appliance in the instructions for use as suitable or hob guards incorporated in the appliance. The use of inappropriate guards can cause accidents.
- The inner glass panels of the oven doors can be removed for ease of cleaning. Turn off the power supply and make sure the oven is cool. To remove the glass panels, simply push the glass upwards and lift out of the retaining clips.
- **(Gas appliance):** The nominal heat input for each of the burners, expressed in kilowatts based on the gross calorific value and in grams per hour for liquefied petroleum gas are shown in the table below:

| Hotplate Burner | Bypass Screw* | Natural Gas G20 | | L.P. Gas | |
|----------------------------|---------------|-----------------|----------|------------------|----------|
| | | 20 mb | | 29 / 37 mb | |
| | | | Injector | | Injector |
| Wok Burner | 62 | 4,0 kW | 148 | 4,0 kW (291 g/h) | 103 |
| Rapide / Large | 40 | 3,0 kW | 134 | 3,0 kW (218 g/h) | 87 |
| SemiRapide / Medium | 32 | 1,7 kW | 109 | 1,7 kW (124 g/h) | 68 |
| Auxiliary / Small | 28 | 1,0 kW | 75 | 1,0 kW (73 g/h) | 51 |

* The valves in this cooker are fitted with adjustable bypass screws. The appliance is supplied set for natural gas. For LPG conversion the bypass screws must be screwed all the way down.

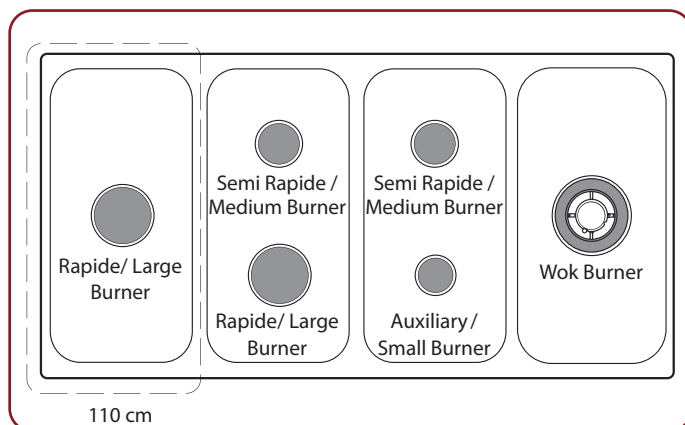

Environmental & Performance Characteristics

| Fiche | 65/2014 |
|--|--|
| Trade Mark | Kitchener / Rangemaster / Falcon |
| Model | Camden / Cotswold / Classic / Estate / Infusion / Infusion Classic / Longstock / Professional / Toledo |
| Product Width | 90 |
| Number of cavities | 2 |
| Left Oven | Fanned |
| Type | Electric |
| Volume (Litres) | 80 |
| Energy Consumption - Conventional (KWh/cycle) | |
| Energy Consumption - Forced Air Convection (KWh/cycle) | 0.83 |
| Energy Efficiency Index - Conventional (EEI) | |
| Energy Efficiency Index - Forced Air Convection (EEI) | 94.4 |
| Energy Class | A |
| Right Oven | Fanned |
| Type | Electric |
| Volume (Litres) | 67 |
| Energy Consumption - Conventional (KWh/cycle) | |
| Energy Consumption - Forced Air Convection (KWh/cycle) | 0.79 |
| Energy Efficiency Index - Conventional (EEI) | |
| Energy Efficiency Index - Forced Air Convection (EEI) | 95.6 |
| Energy Class | A |
| Appliance Mass (Kg) | 124 |

| Fiche | 65/2014 |
|--|--|
| Trade Mark | Kitchener / Rangemaster / Falcon |
| Model | Camden / Cotswold / Classic / Professional |
| Product Width | 100 |
| Number of cavities | 2 |
| Left Oven | Fanned |
| Type | Electric |
| Volume (Litres) | 80 |
| Energy Consumption - Conventional (KWh/cycle) | |
| Energy Consumption - Forced Air Convection (KWh/cycle) | 0.83 |
| Energy Efficiency Index - Conventional (EEI) | |
| Energy Efficiency Index - Forced Air Convection (EEI) | 94.4 |
| Energy Class | A |
| Right Oven | Fanned |
| Type | Electric |
| Volume (Litres) | 82 |
| Energy Consumption - Conventional (KWh/cycle) | |
| Energy Consumption - Forced Air Convection (KWh/cycle) | 0.78 |
| Energy Efficiency Index - Conventional (EEI) | |
| Energy Efficiency Index - Forced Air Convection (EEI) | 87.3 |
| Energy Class | A |
| Appliance Mass (Kg) | 133 |

| Fiche | 65/2014 |
|--|---|
| Trade Mark | Kitchener / Rangemaster / Falcon |
| Model | Camden / Cotswold / Classic / Infusion / Infusion Classic / Longstock / Professional / Toledo |
| Product Width | 110 |
| Number of cavities | 2 |
| Left Oven | Fanned |
| Type | Electric |
| Volume (Litres) | 80 |
| Energy Consumption - Conventional (KWh/cycle) | |
| Energy Consumption - Forced Air Convection (KWh/cycle) | 0.83 |
| Energy Efficiency Index - Conventional (EEI) | |
| Energy Efficiency Index - Forced Air Convection (EEI) | 94.4 |
| Energy Class | A |
| Right Oven | Fanned |
| Type | Electric |
| Volume (Litres) | 80 |
| Energy Consumption - Conventional (KWh/cycle) | |
| Energy Consumption - Forced Air Convection (KWh/cycle) | 0.83 |
| Energy Efficiency Index - Conventional (EEI) | |
| Energy Efficiency Index - Forced Air Convection (EEI) | 94.4 |
| Energy Class | A |
| Appliance Mass (Kg) | 147 |

| Fiche | 65/2014 |
|--|--|
| Trade Mark | Kitchener / Rangemaster / Stanley |
| Model | Classic Deluxe / Edge Deluxe / Encore Deluxe / Estel Deluxe / Leckford Deluxe / Longstock Deluxe / Professional Deluxe / Arina / Nexus / Stanley Supreme |
| Product Width | 90 |
| Number of cavities | 2 |
| Left Oven | Multifunction |
| Type | Electric |
| Volume (Litres) | 80 |
| Energy Consumption - Conventional (KWh/cycle) | 1.01 |
| Energy Consumption - Forced Air Convection (KWh/cycle) | 0.88 |
| Energy Efficiency Index - Conventional (EEI) | 114 |
| Energy Efficiency Index - Forced Air Convection (EEI) | 100 |
| Energy Class | A |
| Right Oven | Fanned |
| Type | Electric |
| Volume (Litres) | 67 |
| Energy Consumption - Conventional (KWh/cycle) | |
| Energy Consumption - Forced Air Convection (KWh/cycle) | 0.79 |
| Energy Efficiency Index - Conventional (EEI) | |
| Energy Efficiency Index - Forced Air Convection (EEI) | 95.6 |
| Energy Class | A |
| Appliance Mass (Kg) | 124 |

| Fiche | 65/2014 |
|--|---|
| Trade Mark | Kitchener / Rangemaster / Stanley |
| Model | Classic Deluxe / Edge Deluxe / Encore Deluxe / Estel Deluxe / Professional Deluxe / Arina / Nexus |
| Product Width | 100 |
| Number of cavities | 2 |
| Left Oven | Multifunction |
| Type | Electric |
| Volume (Litres) | 80 |
| Energy Consumption - Conventional (KWh/cycle) | 1.01 |
| Energy Consumption - Forced Air Convection (KWh/cycle) | 0.88 |
| Energy Efficiency Index - Conventional (EEI) | 114 |
| Energy Efficiency Index - Forced Air Convection (EEI) | 100 |
| Energy Class | A |
| Right Oven | Fanned |
| Type | Electric |
| Volume (Litres) | 82 |
| Energy Consumption - Conventional (KWh/cycle) | |
| Energy Consumption - Forced Air Convection (KWh/cycle) | 0.78 |
| Energy Efficiency Index - Conventional (EEI) | |
| Energy Efficiency Index - Forced Air Convection (EEI) | 87.3 |
| Energy Class | A |
| Appliance Mass (Kg) | 133 |

| Fiche | 65/2014 |
|--|--|
| Trade Mark | Kitchener / Rangemaster / Stanley |
| Model | Classic Deluxe / Edge Deluxe / Encore Deluxe / Estel Deluxe / Leckford Deluxe / Longstock Deluxe / Professional Deluxe / Arina / Nexus / Stanley Supreme |
| Product Width | 110 |
| Number of cavities | 2 |
| Left Oven | Multifunction |
| Type | Electric |
| Volume (Litres) | 80 |
| Energy Consumption - Conventional (KWh/cycle) | 1.01 |
| Energy Consumption - Forced Air Convection (KWh/cycle) | 0.88 |
| Energy Efficiency Index - Conventional (EEI) | 114 |
| Energy Efficiency Index - Forced Air Convection (EEI) | 100 |
| Energy Class | A |
| Right Oven | Fanned |
| Type | Electric |
| Volume (Litres) | 80 |
| Energy Consumption - Conventional (KWh/cycle) | |
| Energy Consumption - Forced Air Convection (KWh/cycle) | 0.83 |
| Energy Efficiency Index - Conventional (EEI) | |
| Energy Efficiency Index - Forced Air Convection (EEI) | 94.4 |
| Energy Class | A |
| Appliance Mass (Kg) | 147 |

| Fiche | 65/2014 |
|--|---|
| Trade Mark | Kitchener / Rangemaster / Stanley |
| Model | Classic Deluxe / Estel Deluxe / Professional Deluxe / Arina / Nexus |
| Product Width | 90 |
| Number of cavities | 1 |
| Single Cavity Oven | Multifunction |
| Type | Electric |
| Volume (Litres) | 114 |
| Energy Consumption - Conventional (KWh/cycle) | 1.16 |
| Energy Consumption - Forced Air Convection (KWh/cycle) | 0.97 |
| Energy Efficiency Index - Conventional (EEI) | 112.8 |
| Energy Efficiency Index - Forced Air Convection (EEI) | 93.9 |
| Energy Class | A |
| Appliance Mass (Kg) | 124 |

Electric Hobs

5 Zone Induction Hob

| Model Identification | Rangemaster Brand - Professional+ | |
|---|-----------------------------------|-----------|
| Type of Hob | | Electric |
| Heating Technology | | Induction |
| No. of Cooking Zones and/or Areas | | 5 |
| Zone 1 - Diameter Ø | cm | 14.5 |
| Energy Consumption (ECElectric Cooking) | Wh/Kg | 181 |
| Zone 2 - Diameter Ø | cm | 21 |
| Energy Consumption (ECElectric Cooking) | Wh/Kg | 173 |
| Zone 3 - Diameter Ø | cm | 21 |
| Energy Consumption (ECElectric Cooking) | Wh/Kg | 173 |
| Zone 4 - Diameter Ø | cm | 21 |
| Energy Consumption (ECElectric Cooking) | Wh/Kg | 173 |
| Zone 5 - Diameter Ø | cm | 14.5 |
| Energy Consumption (ECElectric Cooking) | Wh/Kg | 181 |
| Energy Consumption (ECElectric Hob) | Wh/Kg | 176 |

5 Zone Induction Hob with 1 Bridging

| Model Identification | Rangemaster Brand - Professional Deluxe | |
|---|---|-----------|
| Type of Hob | | Electric |
| Heating Technology | | Induction |
| No. of Cooking Zones and/or Areas | | 5 |
| Zone 1 - Diameter Ø | cm | 18 |
| Energy Consumption (ECElectric Cooking) | Wh/Kg | 189 |
| Zone 2 - Diameter Ø | cm | 18 |
| Energy Consumption (ECElectric Cooking) | Wh/Kg | 189 |
| Zone 3 - Diameter Ø | cm | 21 |
| Energy Consumption (ECElectric Cooking) | Wh/Kg | 173 |
| Zone 4 - Diameter Ø | cm | 21 |
| Energy Consumption (ECElectric Cooking) | Wh/Kg | 173 |
| Zone 5 - Diameter Ø | cm | 14.5 |
| Energy Consumption (ECElectric Cooking) | Wh/Kg | 181 |
| Energy Consumption (ECElectric Hob) | Wh/Kg | 181 |

5 Zone Induction Hob

| Model Identification | Rangemaster Brand - Classic / Infusion Classic / Longstock / Infusion / Toledo | |
|---|---|-----------|
| Type of Hob | | Electric |
| Heating Technology | | Induction |
| No. of Cooking Zones and/or Areas | | 5 |
| Zone 1 - Diameter Ø | cm | 18.5 |
| Energy Consumption (ECElectric Cooking) | Wh/Kg | 180 |
| Zone 2 - Diameter Ø | cm | 15.5 |
| Energy Consumption (ECElectric Cooking) | Wh/Kg | 172 |
| Zone 3 - Diameter Ø | cm | 18.5 |
| Energy Consumption (ECElectric Cooking) | Wh/Kg | 180 |
| Zone 4 - Diameter Ø | cm | 15.5 |
| Energy Consumption (ECElectric Cooking) | Wh/Kg | 172 |
| Zone 5 - Diameter Ø | cm | 18.5 |
| Energy Consumption (ECElectric Cooking) | Wh/Kg | 180 |
| Energy Consumption (ECElectric Hob) | Wh/Kg | 175 |

5 Zone Induction Hob

| Model Identification | Rangemaster Brand - Classic Deluxe/ Edge Deluxe/ Estel Deluxe/ Longstock Deluxe/ Nexus/ Arina Stanley Brand - Supreme | |
|---|--|-----------|
| Type of Hob | | Electric |
| Heating Technology | | Induction |
| No. of Cooking Zones and/or Areas | | 5 |
| Zone 1 - Diameter Ø | cm | 18 |
| Energy Consumption (ECElectric Cooking) | Wh/Kg | 176 |
| Zone 2 - Diameter Ø | cm | 18 |
| Energy Consumption (ECElectric Cooking) | Wh/Kg | 176 |
| Zone 3 - Diameter Ø | cm | 21 |
| Energy Consumption (ECElectric Cooking) | Wh/Kg | 180 |
| Zone 4 - Diameter Ø | cm | 18 |
| Energy Consumption (ECElectric Cooking) | Wh/Kg | 169 |
| Zone 5 - Diameter Ø | cm | 15.5 |
| Energy Consumption (ECElectric Cooking) | Wh/Kg | 183 |
| Energy Consumption (ECElectric Hob) | Wh/Kg | 177 |

5 Zone Induction Hob

| Model Identification | Kitchener Brand - Cotswold / Camden Rangemaster Brand - Estate Falcon Brand - Kitchener | |
|---|---|-----------|
| Type of Hob | | Electric |
| Heating Technology | | Induction |
| No. of Cooking Zones and/or Areas | | 5 |
| Zone 1 - Diameter Ø | cm | 14.5 |
| Energy Consumption (ECElectric Cooking) | Wh/Kg | 163 |
| Zone 2 - Diameter Ø | cm | 16 |
| Energy Consumption (ECElectric Cooking) | Wh/Kg | 185 |
| Zone 3 - Diameter Ø | cm | 20 |
| Energy Consumption (ECElectric Cooking) | Wh/Kg | 167 |
| Zone 4 - Diameter Ø | cm | 16 |
| Energy Consumption (ECElectric Cooking) | Wh/Kg | 190 |
| Zone 5 - Diameter Ø | cm | 14.5 |
| Energy Consumption (ECElectric Cooking) | Wh/Kg | 184 |
| Energy Consumption (ECElectric Hob) | Wh/Kg | 178 |

5 Zone Ceramic Hob - 90 & 100

| Model Identification | Kitchener Brand - Cotswold / Camden Falcon Brand - Classic / Prof+ | |
|---|---|----------|
| Type of Hob | | Electric |
| Heating Technology | | Radiant |
| No. of Cooking Zones and/or Areas | | 5 |
| Zone 1 - Diameter Ø | cm | 14.5 |
| Energy Consumption (ECElectric Cooking) | Wh/Kg | 180 |
| Zone 2 - Diameter Ø | cm | 18.5 |
| Energy Consumption (ECElectric Cooking) | Wh/Kg | 177 |
| Zone 3 - Diameter Ø | cm | 14.5 |
| Energy Consumption (ECElectric Cooking) | Wh/Kg | 180 |
| Zone 4 - Diameter Ø | cm | 18.5 |
| Energy Consumption (ECElectric Cooking) | Wh/Kg | 177 |
| Zone 5 - Diameter Ø | cm | 21 |
| Energy Consumption (ECElectric Cooking) | Wh/Kg | 175 |
| Energy Consumption (ECElectric Hob) | Wh/Kg | 177 |

6 Zone Ceramic Hob - 110

| | | |
|---|---|------|
| Model Identification | Kitchener Brand - Cotswold / Camden Rangemaster Brand - Classic / Prof+ / Estate | |
| Type of Hob | Electric | |
| Heating Technology | Radiant | |
| No. of Cooking Zones and/or Areas | 6 | |
| Zone 1 - Diameter Ø | cm | 14.5 |
| Energy Consumption (ECElectric Cooking) | Wh/Kg | 175 |
| Zone 2 - Diameter Ø | cm | 14.5 |
| Energy Consumption (ECElectric Cooking) | Wh/Kg | 180 |
| Zone 3 - Diameter Ø | cm | 18.5 |
| Energy Consumption (ECElectric Cooking) | Wh/Kg | 177 |
| Zone 4 - Diameter Ø | cm | 14.5 |
| Energy Consumption (ECElectric Cooking) | Wh/Kg | 180 |
| Zone 5 - Diameter Ø | cm | 18.5 |
| Energy Consumption (ECElectric Cooking) | Wh/Kg | 177 |
| Zone 6 - Diameter Ø | cm | 14.5 |
| Energy Consumption (ECElectric Cooking) | Wh/Kg | 180 |
| Energy Consumption (ECElectric Hob) | Wh/Kg | 178 |

Gas Hobs

5 Zone Gas Hob - 90 & 100

| | | |
|---|--|----|
| Model Identification | Kitchener Brand - Cotswold / Camden Rangemaster Brand - Classic / Prof+ / Infusion Classic / Longstock / Infusion / Toledo / Classic Dlx / Estel Dlx / Leckford Dlx / Edge Dlx / Prof Dlx / Longstock Dlx / Encore Dlx / Arina / Nexus / Stanley Supreme / Estate | |
| Type of Hob | Gas | |
| No. of Gas Burners | 5 | |
| Auxiliary / Small Burner (EE gas burner) | % | / |
| Semi Rapide / Medium Burner (EE gas burner) | % | 58 |
| Semi Rapide / Medium Burner (EE gas burner) | % | 58 |
| Rapide / Large Burner (EE gas burner) | % | 56 |
| Wok (EE gas burner) | % | 54 |
| Hotplate (EE gas hob) | % | 56 |

5 Zone Gas Hob with Warming Plate - 110

| | | |
|---|--|------|
| Model Identification | Rangemaster Brand - Classic Dlx / Estel Dlx / Leckford Dlx / Edge Dlx / Prof Dlx / Longstock Dlx / Encore Dlx / Arina / Nexus / Stanley Supreme | |
| Type of Hob | Gas | |
| No. of Gas Burners | 5 | |
| Auxiliary / Small Burner (EE gas burner) | % | / |
| Semi Rapide / Medium Burner (EE gas burner) | % | 58 |
| Semi Rapide / Medium Burner (EE gas burner) | % | 58 |
| Rapide / Large Burner (EE gas burner) | % | 56 |
| Wok (EE gas burner) | % | 54 |
| Hotplate (EE gas hob) | % | 56 |
| Type of Hob | Electric | |
| Heating Technology | Radiant | |
| No. of Cooking Zones and/or Areas | 2 | |
| Zone 1 - Diameter Ø | cm | 14.5 |
| Energy Consumption (ECElectric Cooking) | Wh/Kg | 180 |
| Zone 2 - Diameter Ø | cm | 14.5 |
| Energy Consumption (ECElectric Cooking) | Wh/Kg | 180 |

6 Zone Gas Hob - 110

| | | |
|---|--|----|
| Model Identification | Kitchener Brand - Cotswold / Camden Rangemaster Brand - Classic / Prof+ / Infusion Classic / Longstock / Infusion / Toledo / Estate | |
| Type of Hob | Gas | |
| No. of Gas Burners | 6 | |
| Auxiliary / Small Burner | % | / |
| Semi Rapide / Medium Burner (EE gas burner) | % | 58 |
| Semi Rapide / Medium Burner (EE gas burner) | % | 58 |
| Rapide / Large Burner (EE gas burner) | % | 56 |
| Rapide / Large Burner (EE gas burner) | % | 56 |
| Wok (EE gas burner) | % | 54 |
| Hotplate (EE gas hob) | % | 56 |

5 Zone PKR Gas Hob - 90 & 110

| | | |
|---|--|------|
| Model Identification | La Cornue Brand - Cornufé / Albertine | |
| Type of Hob | Gas | |
| No. of Gas Burners | 5 | |
| Semi Rapide / Medium Burner (EE gas burner) | % | 60.8 |
| Rapide / Large Burner (EE gas burner) | % | 58.5 |
| Rapide / Large Burner (EE gas burner) | % | 58.5 |
| Rapide / Large Burner (EE gas burner) | % | 58.5 |
| Ultra Rapide / Large burner (EE gas burner) | % | 55.4 |
| Hotplate (EE gas hob) | % | 58.3 |

Appliance End of Life

Why recycle?

Electrical and electronic equipment is now the fastest growing waste stream in the UK and across the world. Recycling and reusing unwanted electrical or electronics can help save the planet, boost the economy and improve lives. Not only that, electrical and electronic equipment (EEE) contains materials, parts and substances which can be dangerous to the environment and harmful to human health if not disposed of correctly.

www.recycleyourelectricals.org.uk



What can I recycle?

Anything with a plug, battery or cable can be recycled or reused! The materials from recycled electricals can be used in everything from children's playgrounds to lifesaving equipment, while donated tech can help bridge the digital divide.



You'll find this symbol on all your electrical items. It is a reminder to recycle your old electricals, rather than binning them. Appliance End of Life

| | | | | |
|------------------------------|-------------|--------------------------|----------|--------------------------|
| Name of Appliance & Colour* | | | | |
| Appliance Serial Number* | | | | |
| Fuel Type* | Natural Gas | <input type="checkbox"/> | LP Gas | <input type="checkbox"/> |
| | Dual Fuel | <input type="checkbox"/> | Electric | <input type="checkbox"/> |
| Retailer's Name & Address | | | | |
| Date of Purchase | | | | |
| Installer's Name & Address | | | | |
| Installer's Telephone Number | | | | |
| Date of Installation | | | | |

*This information is on the appliance data badge - look in the appliance instructions to find out where the data badge is located.

For warranty compliance, the requirements are that the appliance:

- Has been correctly installed in accordance with current legislation, relevant British and European Standards and Codes of Practice, by a suitably competent person registered with Gas Safe or equivalent body and, where applicable, a qualified electrician.
- Has been used solely for domestic cooking purposes.
- If in use in the UK*, has not been taken abroad as a personal export. (In the Republic of Ireland conditions may vary, so consult your retailer.)
- Is not second-hand or a refurbished appliance. The manufacturer's warranty is not transferable.
- Has not been subject to misuse, accidental damage or modification, and has not deteriorated due to normal domestic wear and tear, and the manufacturer's recommendations concerning cleaning materials have been followed.
- Has not been repaired by persons or organisations other than those authorised to act on behalf of AGA Rangemaster.

Exceptions:

- Items not included under the free 1 year guarantee include pan supports, griddles, wok rings, baking trays, grill pans, trivets, filters, light bulbs and other consumable accessories.
- Any damage caused other than through normal use.
- Breakdowns associated with cooking spillage.
- Cosmetic deterioration deemed to be normal wear and tear.

This warranty is in addition to your Statutory Rights.

* Only certain models can be adapted for use with Mains Gas supplied in the Channel Islands and Isle of Man.

OUT OF WARRANTY

We recommend that Rangemaster appliances are serviced regularly throughout their life to maintain optimum performance and efficiency. Service work should only be carried out by technically competent and suitably qualified personnel.

For your own safety, always make sure that work is carried out by a Gas Safe registered engineer for gas appliances or an approved electrician for electrical models.

For a competitive quote and to arrange for a Rangemaster approved engineer to attend, call Consumer Services on: 01926 457628.

SPARE PARTS

To maintain optimum and safe performance, we recommend that only genuine Rangemaster spare parts are used. These are available from most major spares stockists, including ourselves.

Contact Consumer Services on 01926 457628, who will be happy to help.

STANDARDS

Rangemaster cookers are designed and manufactured to a recognised international quality standard, which meets the requirements of BS EN ISO 9001, BS EN ISO 14001 and OHSAS 18001 for continually improving environmental procedures.

Rangemaster cookers comply with the essential requirements of the appropriate European Directives, and carry the CE mark.

CONSUMER SERVICE

If you have any product enquiries, or in the event of a problem with your appliance once it has been installed, please telephone 01926 457628.

CONSUMER SERVICE LINES OPEN:

Monday to Thursday 8am–6pm
Friday 8am–5pm

13. Warranty

Your manufacturer warranty covers goods of our own brand for defective workmanship and materials for a period of 1 year from the date of purchase. This warranty covers mechanical breakdown and proven cosmetic and manufacturing defects.

You will receive an additional FREE full 12 months guarantee by registering your purchase using the FREEPOST form provided. Alternatively, call free on 0800 587 5747, quoting reference RMGX57A, or register online at www.rangemaster.co.uk.

Any damage, blemishes or chips identified upon receipt of the product must be reported within 7 days – proof of purchase may be required to establish validity. Scratches on the surface of ceramic hobs must be reported within 7 days. Scratches caused by usage are not covered. Accidental damage is not covered by the manufacturer's warranty.



RANGEMASTER®

Clarence Street
Royal Leamington Spa
Warwickshire
CV31 2AD
England

Consumer Services: +44 (0)1926 457628.
Fax: +44 (0)1926 450526
E-mail: consumers@agarangemaster.co.uk
www.rangemaster.co.uk

For UK Trade Enquiries Tel: +44 (0)115 946 4000
Fax: +44 (0)115 973 6602
E-mail: sales@agarangemaster.co.uk

For ROI Enquiries Tel: 1850 302 502

Rangemaster is a trading name of AGA Rangemaster Limited
Registered in England and Wales. Registration No. 354715
Registered Office: c/o Aga Rangemaster, Meadow Lane, Long Eaton, Nottingham, NG10 2GD

AGA RANGEMASTER



08-000040-04a